

ARABIAN RANCHES III

may

ARIA - FLOOR PLANS

DLG
DUBAI LUXURY GUY

 DUBAILUXURYGUY

 +97150 100 5593

 +97150 840 3520

EMAAR

may

ARABIAN RANCHES III

ARIA TOWNHOUSE 4 BEDROOM 1

UNIT	TOTAL AREA
4 PLEX - TH01	
6 PLEX - TH01	2461.81 SQFT 228.71 SQM
8 PLEX - TH01	

KEY PLAN

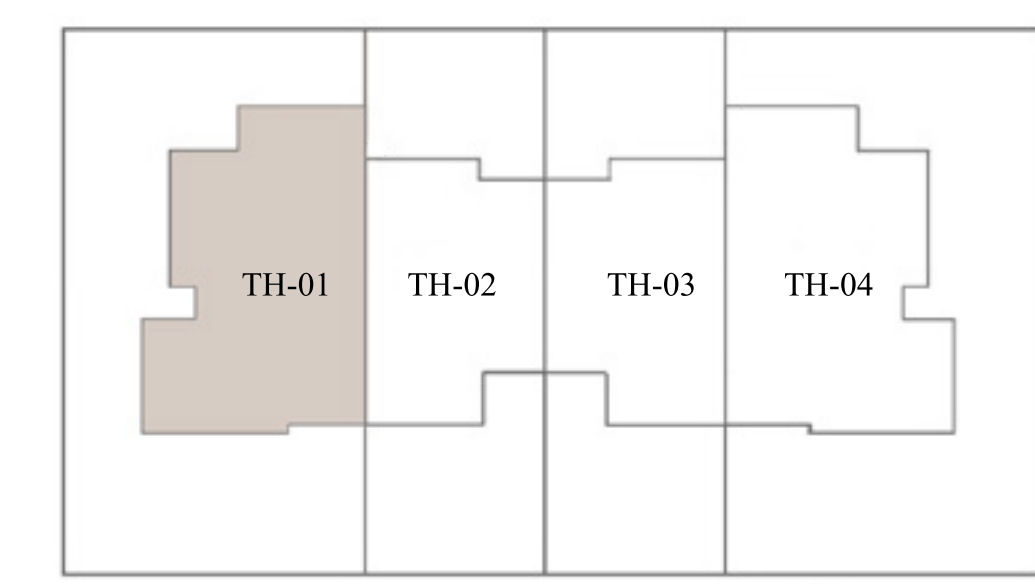

4 PLEX - TH01

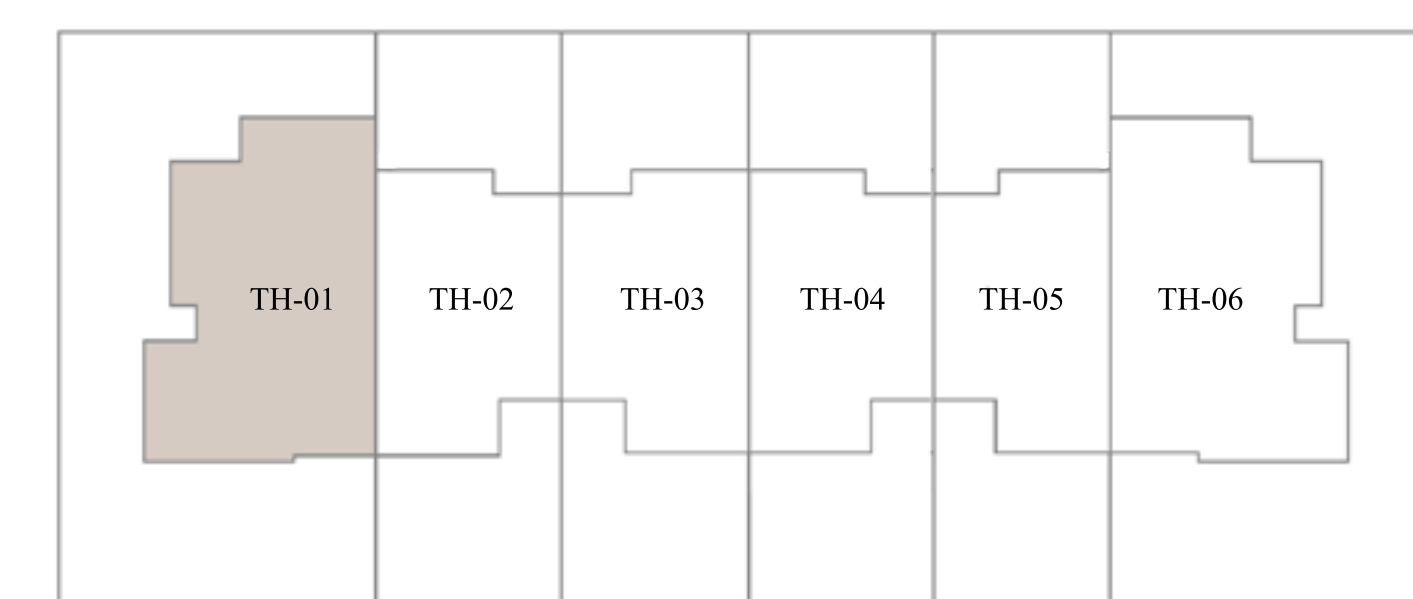

6 PLEX - TH01

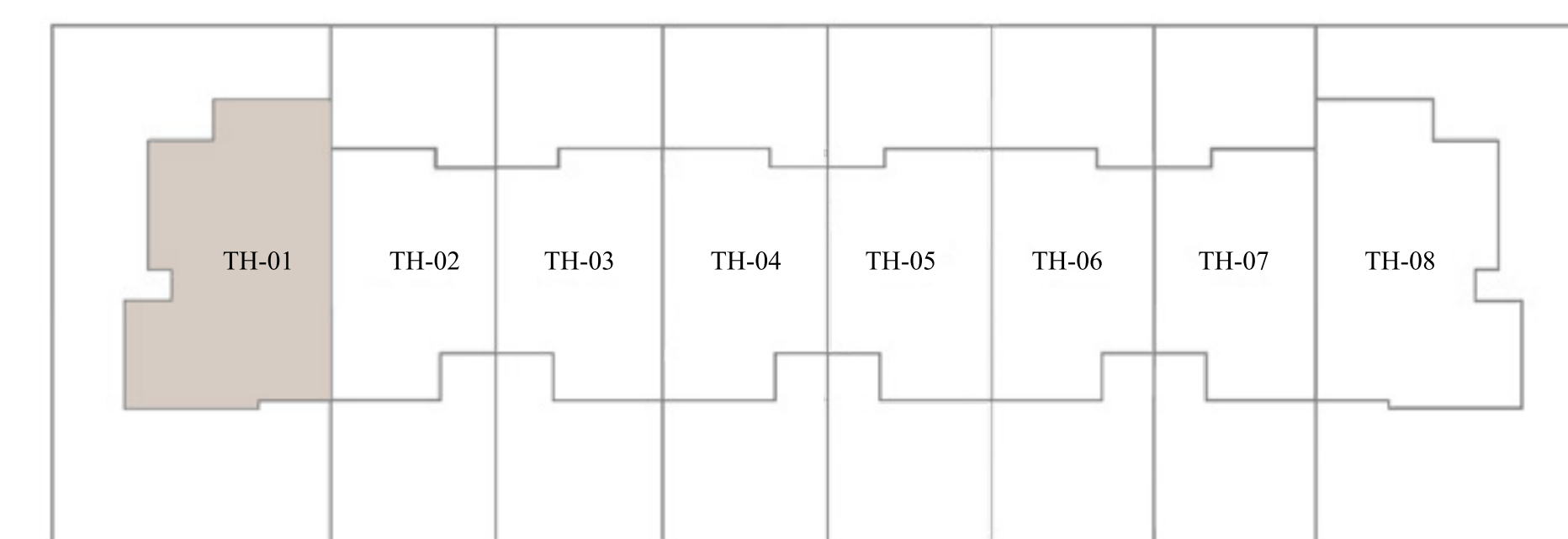

8 PLEX - TH01

DLG
DUBAI LUXURY GUY

Instagram: @DUBAILUXURYGUY
Phone: +97150 100 5593
Phone: +97150 840 3520

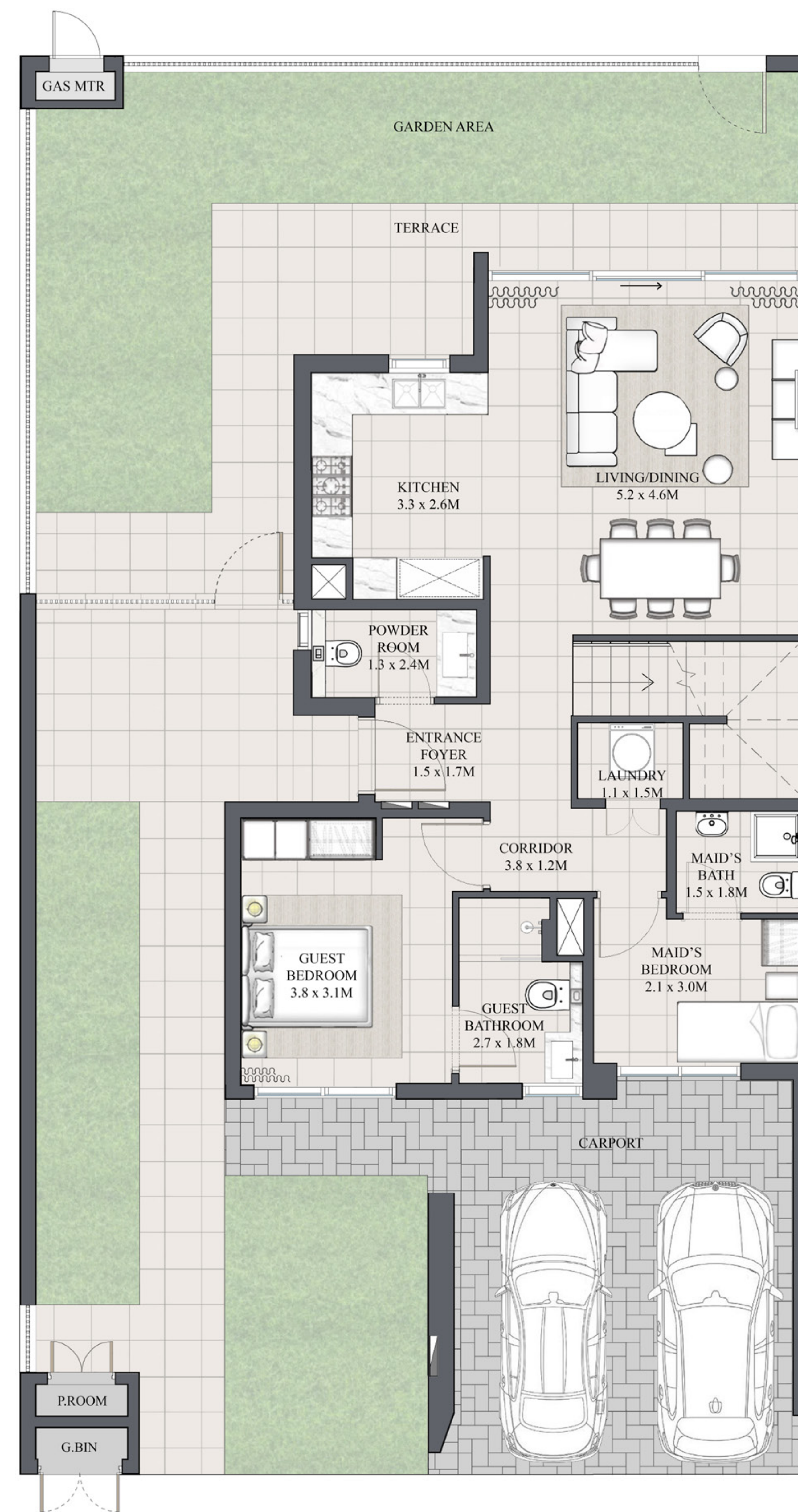

GROUND FLOOR

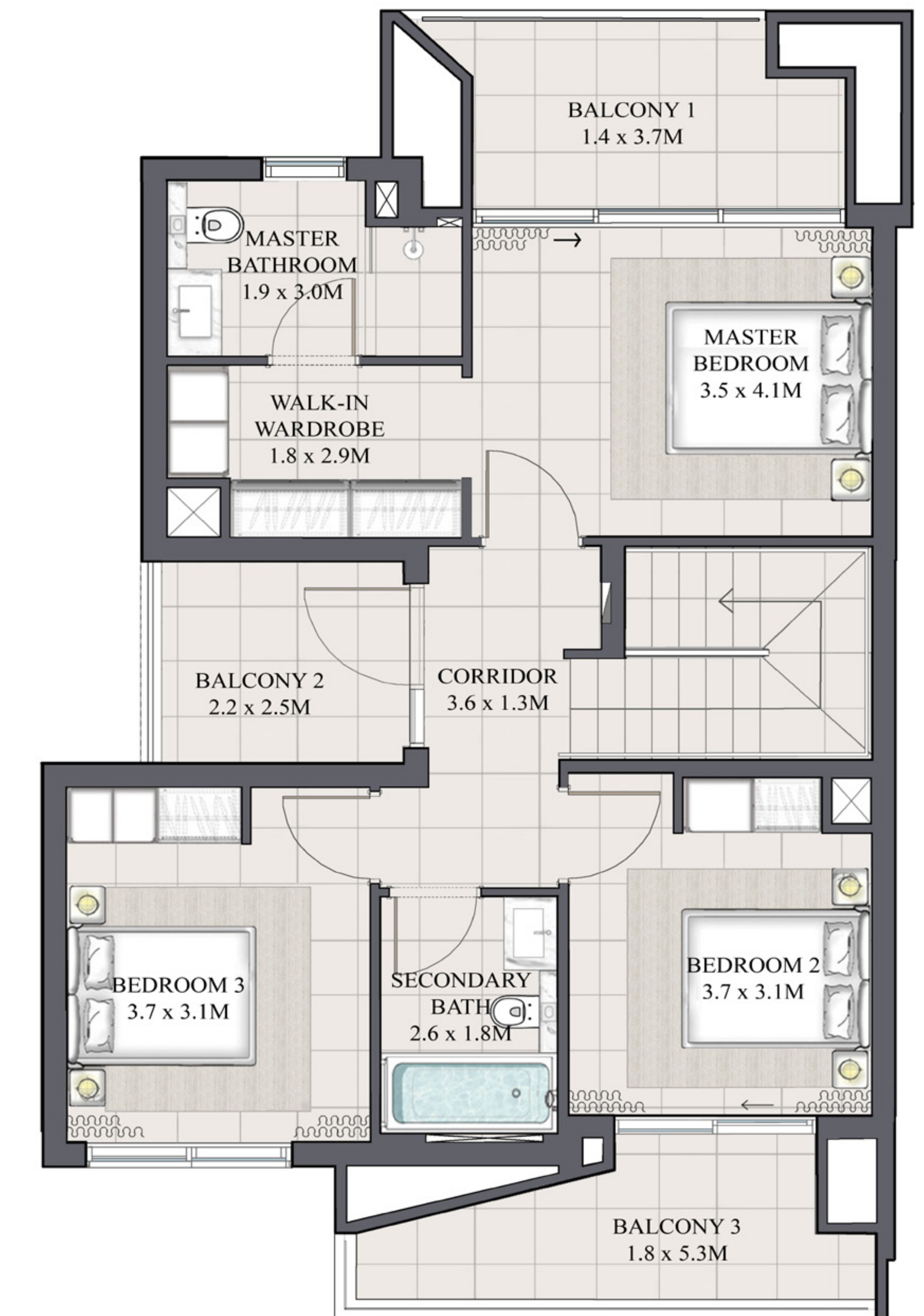

FIRST FLOOR

FLOOR PLAN 1. All dimensions are in imperial and metric, and measured from finish to finish excluding construction tolerances. 2. All materials, dimensions, and drawings are approximate only. 3. Information is subject to change without notice, at developer's absolute discretion. 4. Actual area may vary from the stated area. 5. Drawings not to scale. 6. All images used are for illustrative purposes only and do not represent the actual size, features, specifications, fittings, and furnishings. 7. The developer reserves the right to make revisions / alterations, at it's absolute discretion, without any liability whatsoever.

EMAAR

may

ARABIAN RANCHES III

ARIA TOWNHOUSE 4 BEDROOM 1M MIRRORED

UNIT	TOTAL AREA	
4 PLEX - TH04		
6 PLEX - TH06	2461.81 SQFT	228.71 SQM
8 PLEX - TH08		

KEY PLAN

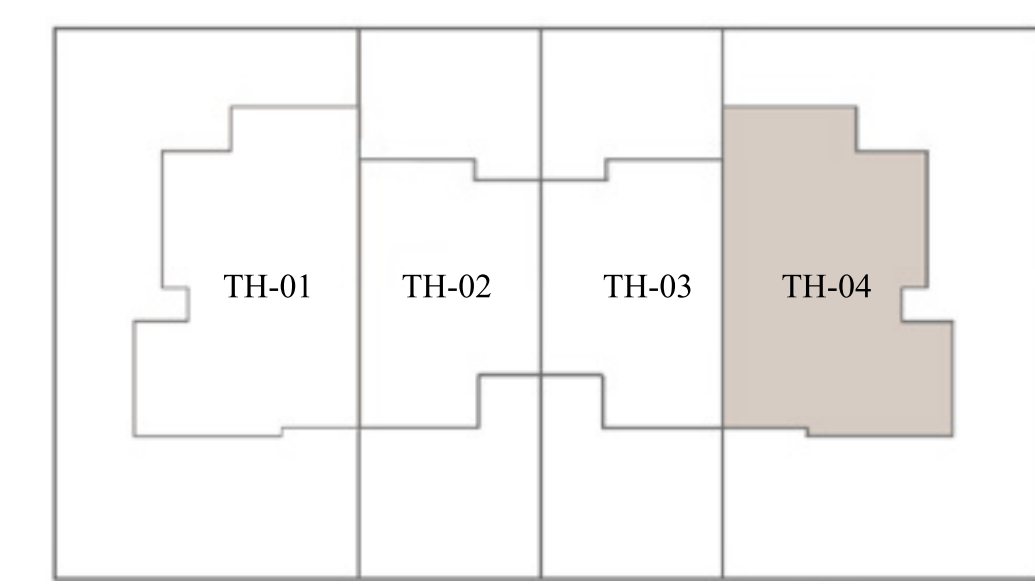

4 PLEX - TH04

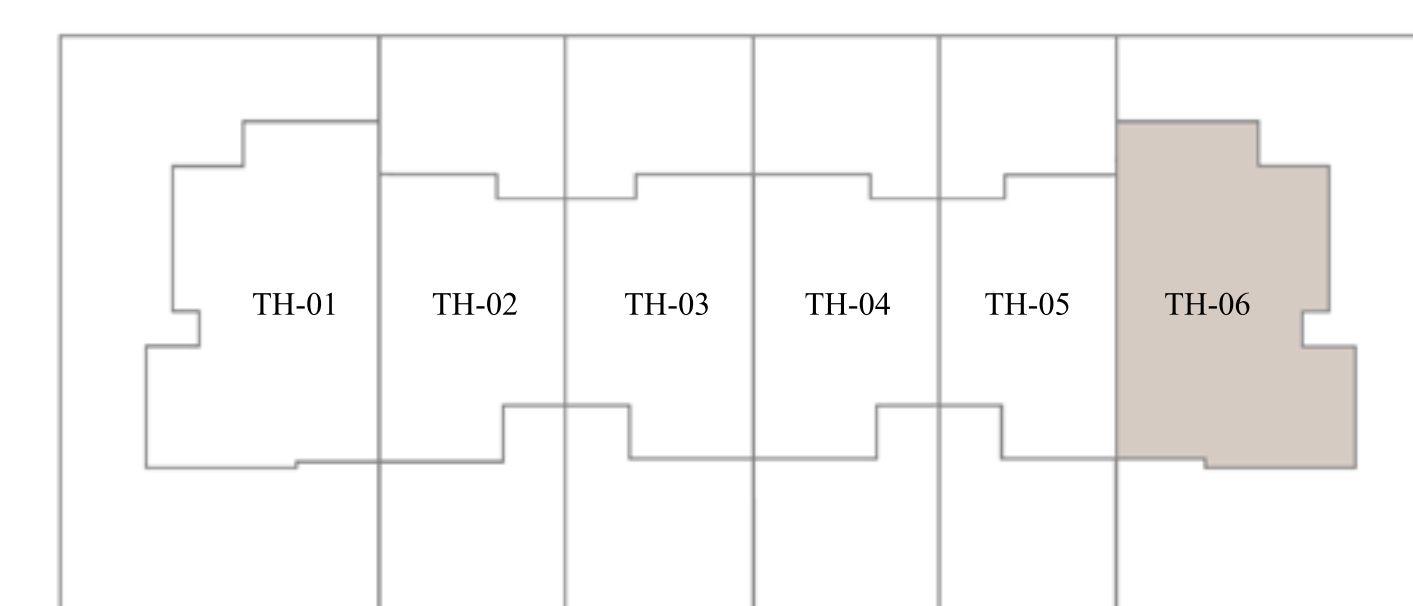

6 PLEX - TH06

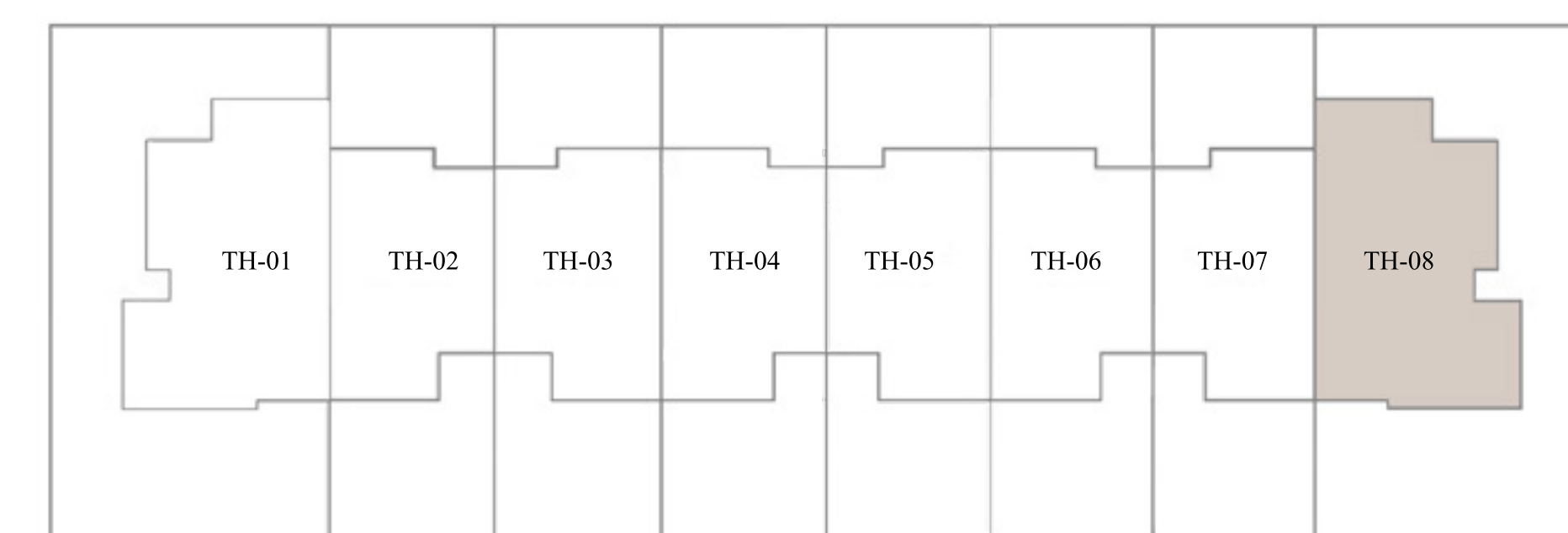

8 PLEX - TH08



GROUND FLOOR

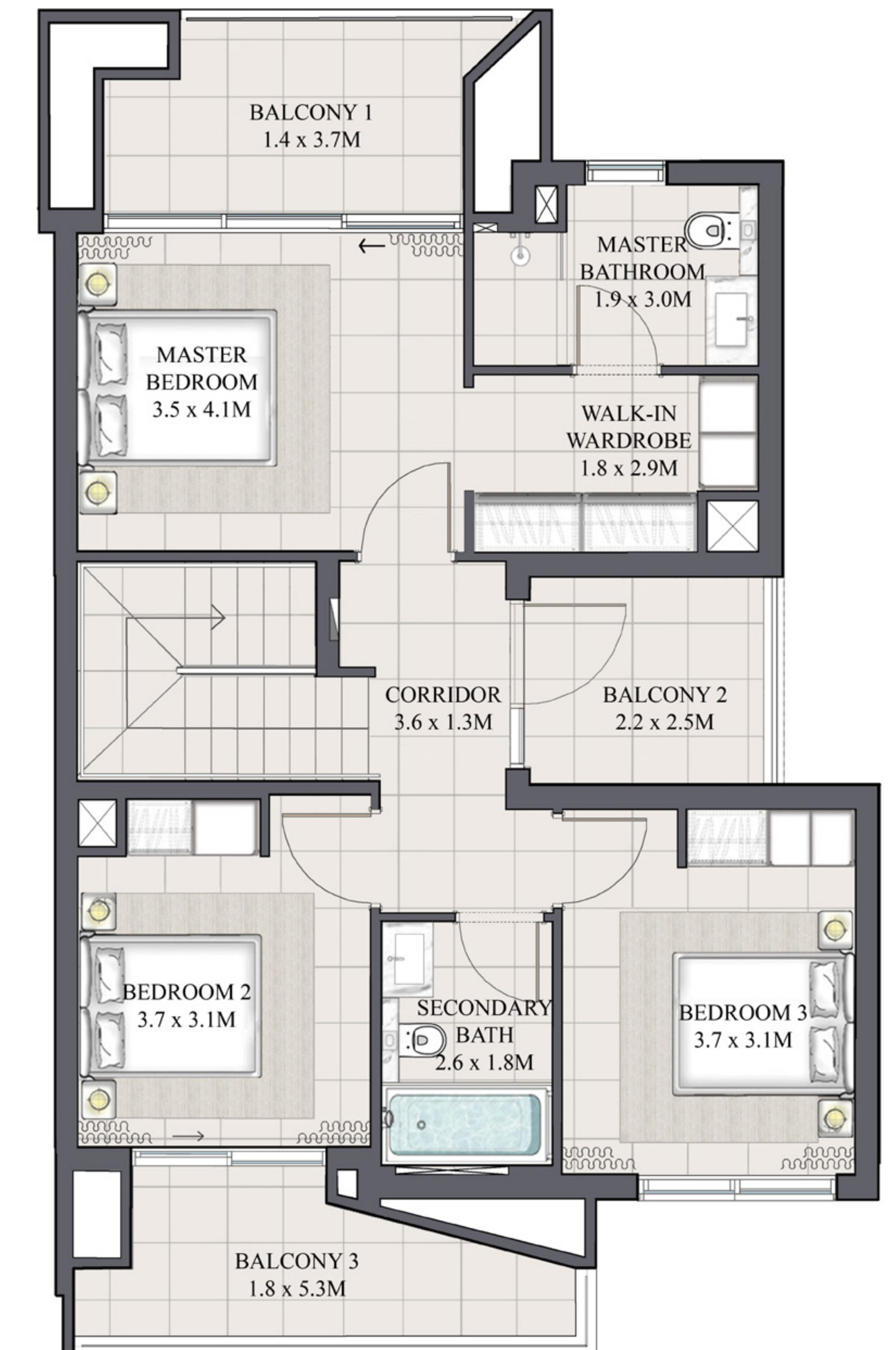

DLG
DUBAI LUXURY GUY

@DUBAILUXURYGUY
 +97150 100 5593
 +97150 840 3520

FLOOR PLAN 1. All dimensions are in imperial and metric, and measured from finish to finish excluding construction tolerances. 2. All materials, dimensions, and drawings are approximate only. 3. Information is subject to change without notice, at developer's absolute discretion. 4. Actual area may vary from the stated area. 5. Drawings not to scale. 6. All images used are for illustrative purposes only and do not represent the actual size, features, specifications, fittings, and furnishings. 7. The developer reserves the right to make revisions / alterations, at it's absolute discretion, without any liability whatsoever.

EMAAR

may

ARABIAN RANCHES III

ARIA TOWNHOUSE 3 BEDROOM 1

UNIT	TOTAL AREA	
4 PLEX - TH02		
6 PLEX - TH02	1989.28 SQFT	184.81 SQM
8 PLEX - TH02		

KEY PLAN

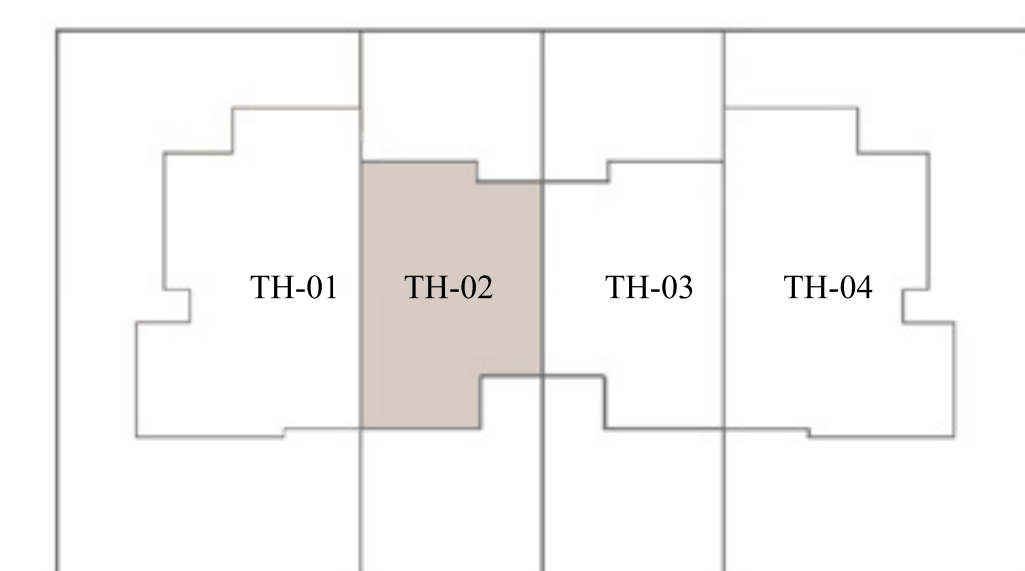

4 PLEX - TH02

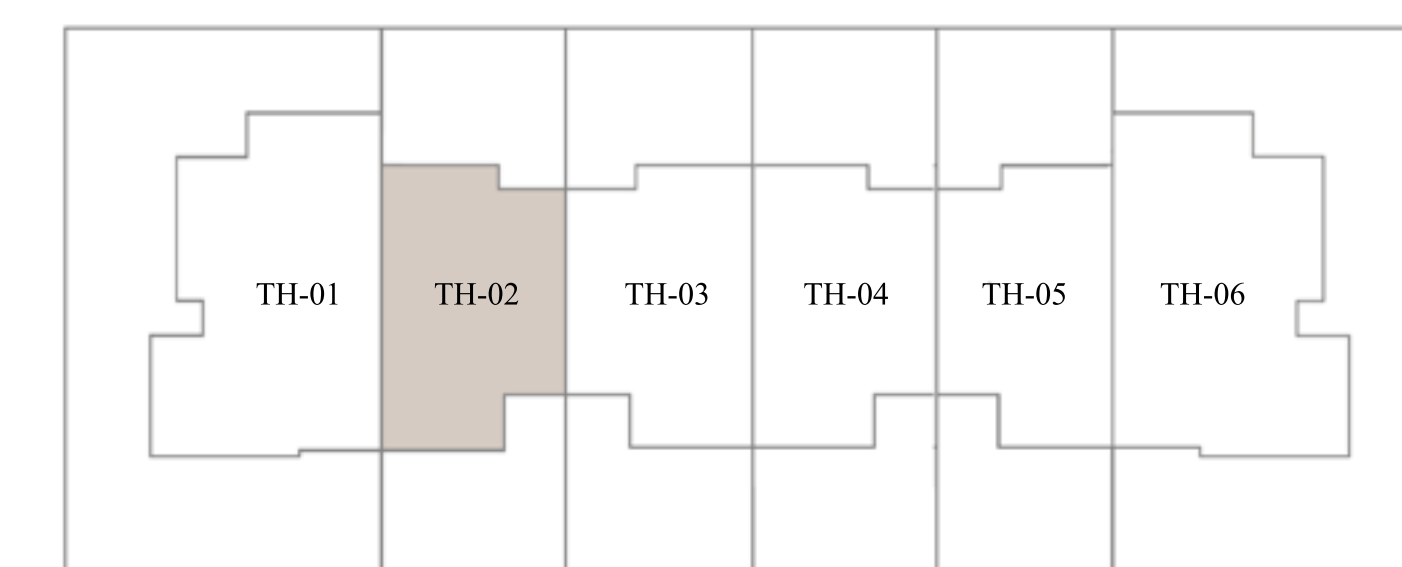

6 PLEX - TH02

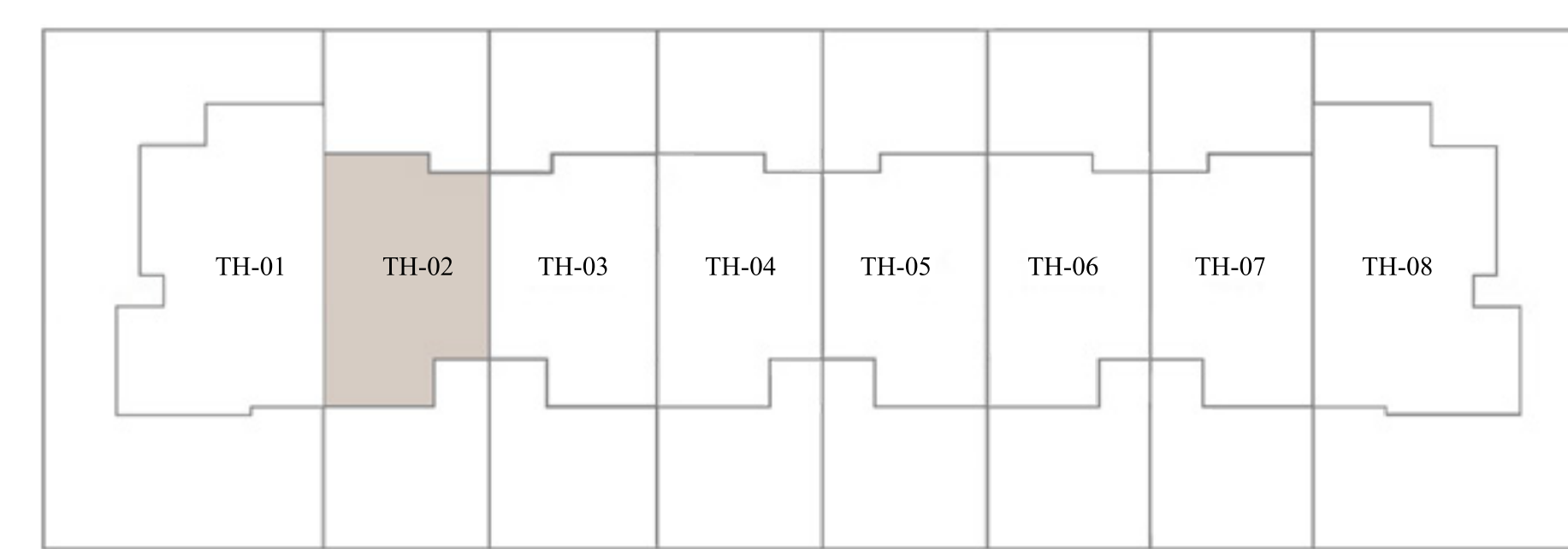

8 PLEX - TH02

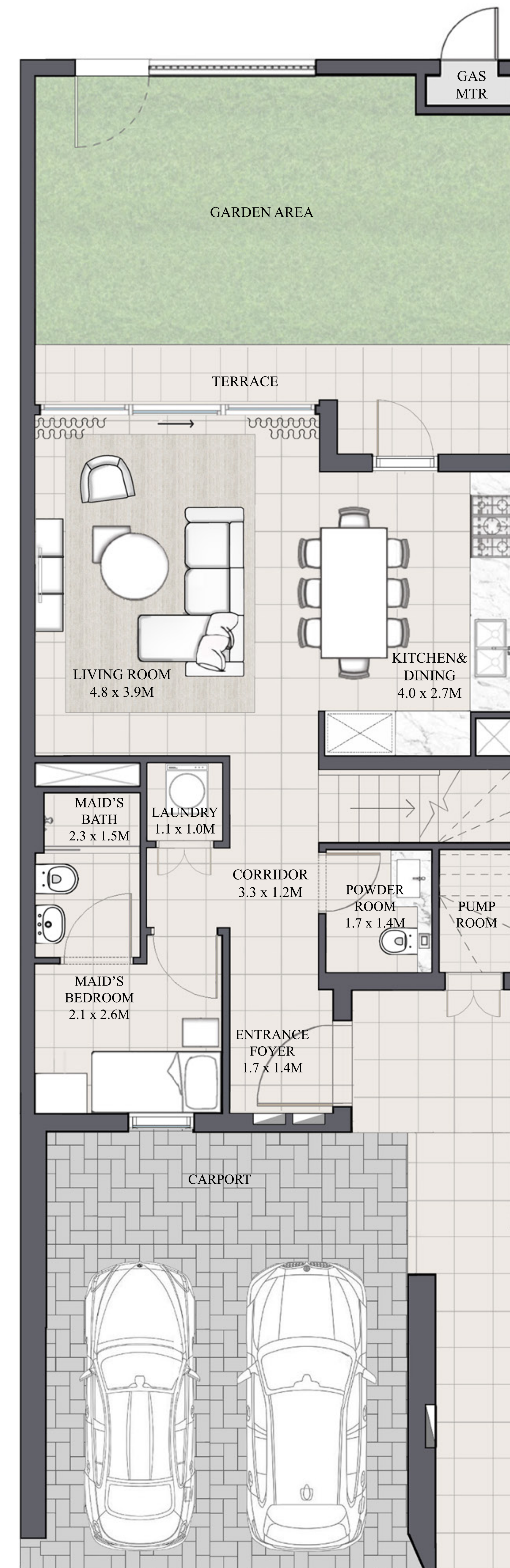

GROUND FLOOR

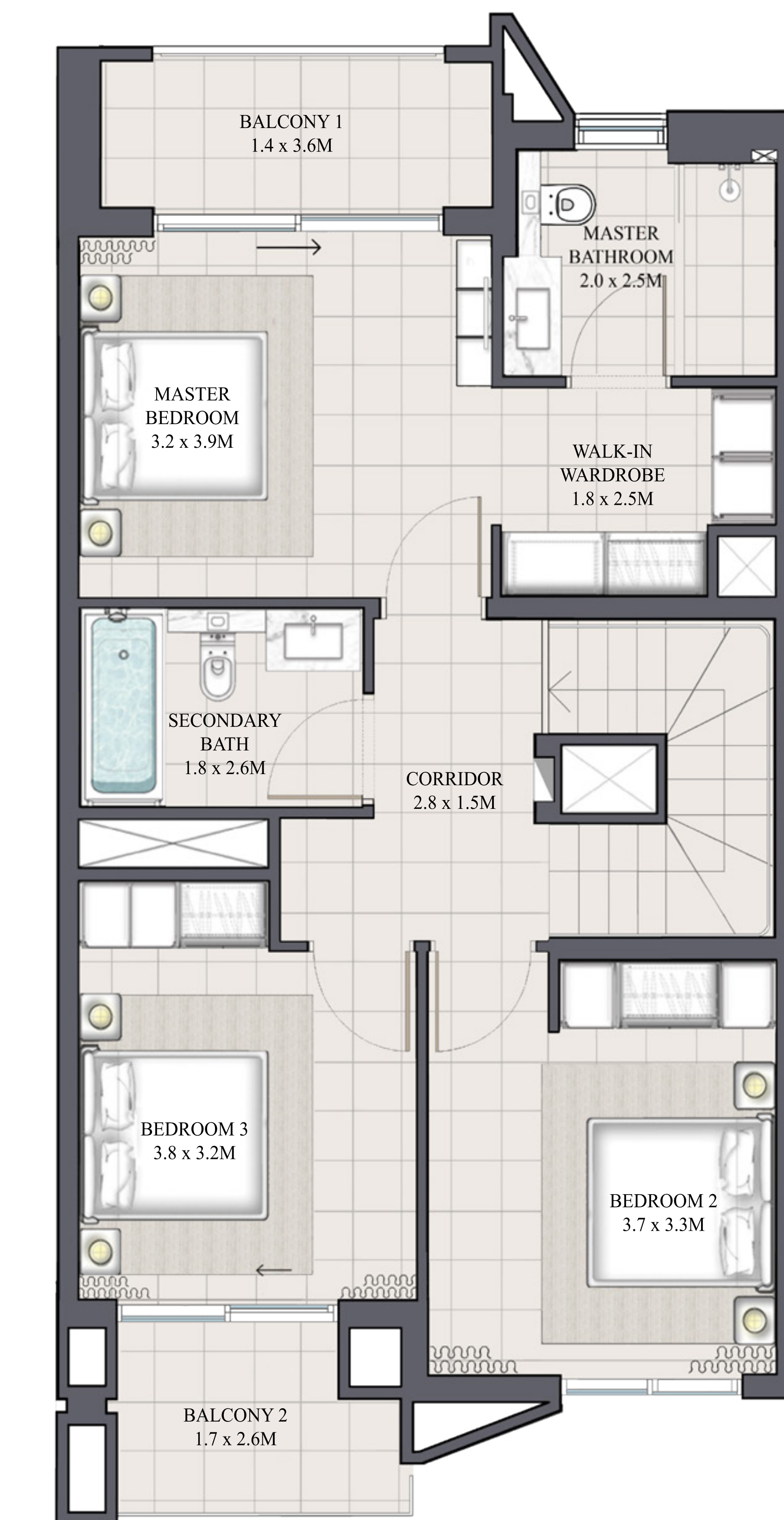

FIRST FLOOR

DLG
DUBAI LUXURY GUY

Instagram: @DUBAILUXURYGUY
 WhatsApp: +97150 100 5593
 Phone: +97150 840 3520

FLOOR PLAN 1. All dimensions are in imperial and metric, and measured from finish to finish excluding construction tolerances. 2. All materials, dimensions, and drawings are approximate only. 3. Information is subject to change without notice, at developer's absolute discretion. 4. Actual area may vary from the stated area. 5. Drawings not to scale. 6. All images used are for illustrative purposes only and do not represent the actual size, features, specifications, fittings, and furnishings. 7. The developer reserves the right to make revisions / alterations, at its absolute discretion, without any liability whatsoever.

may

ARABIAN RANCHES III

ARIA TOWNHOUSE 3 BEDROOM 1 M MIRRORED

UNIT	TOTAL AREA	
4 PLEX - TH03		
6 PLEX - TH05	1989.28 SQFT	184.81 SQM
8 PLEX - TH07		

KEY PLAN

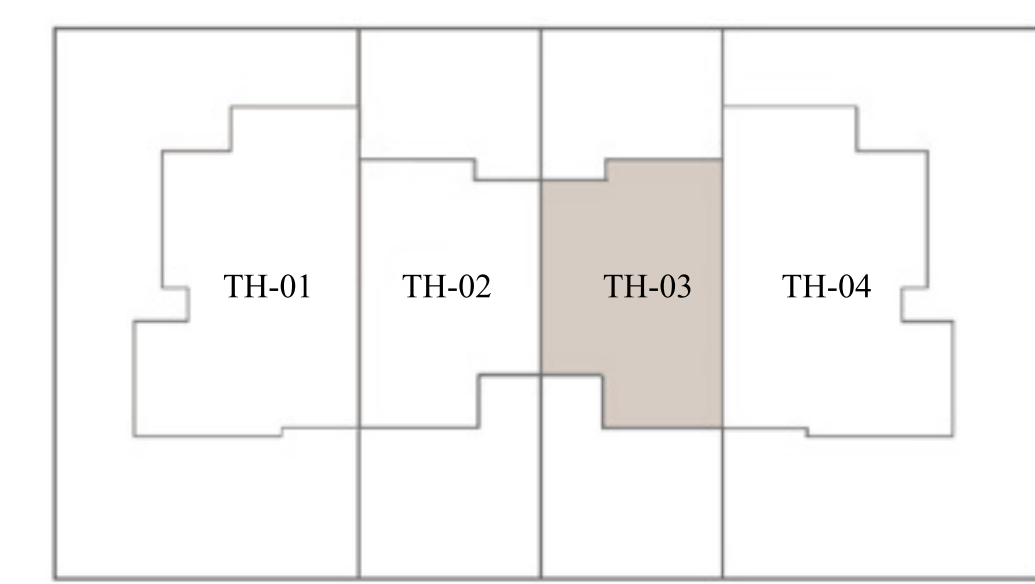

4 PLEX - TH03

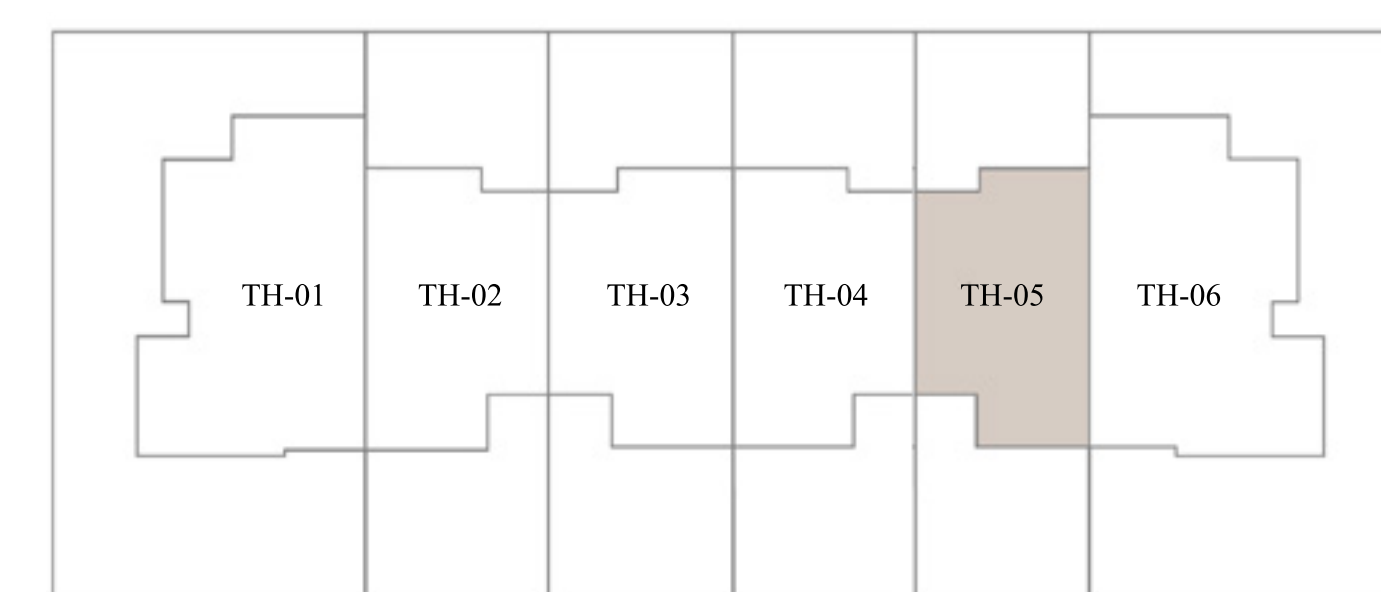

6 PLEX - TH05

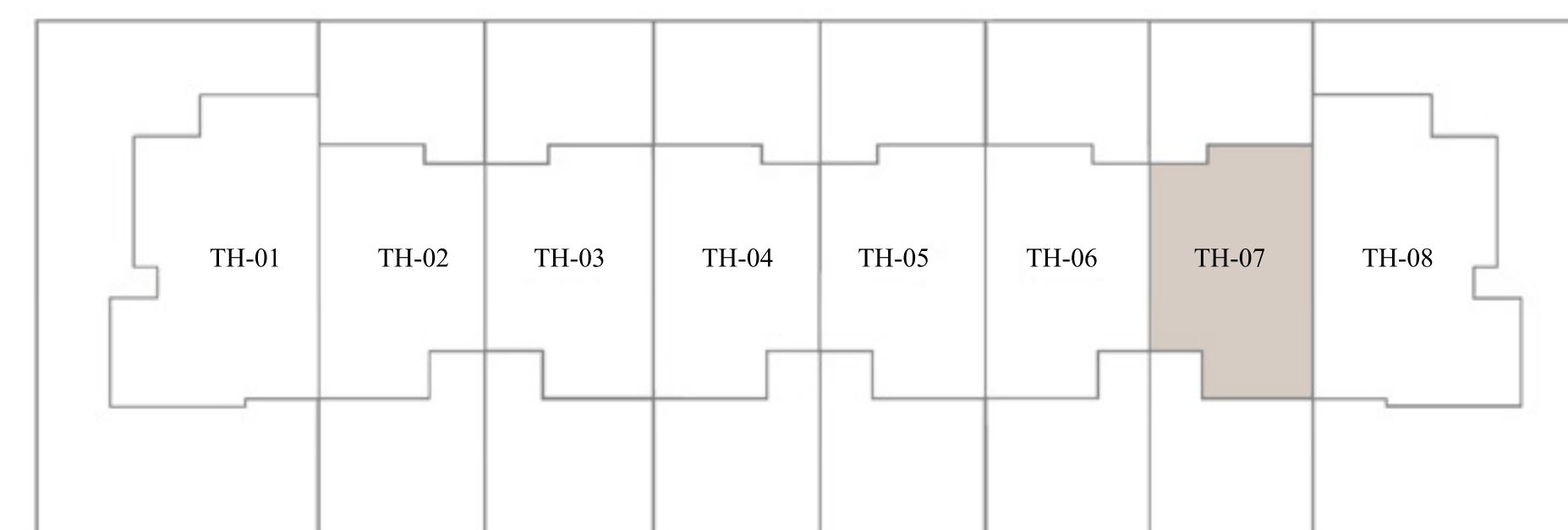

8 PLEX - TH07

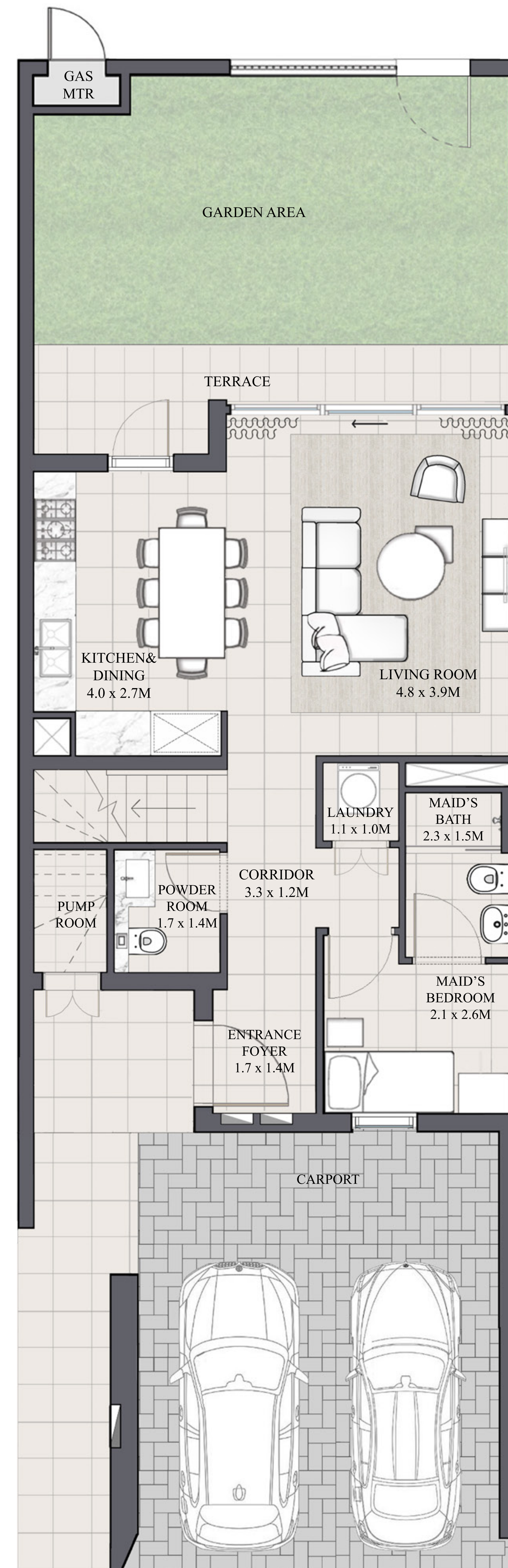

GROUND FLOOR

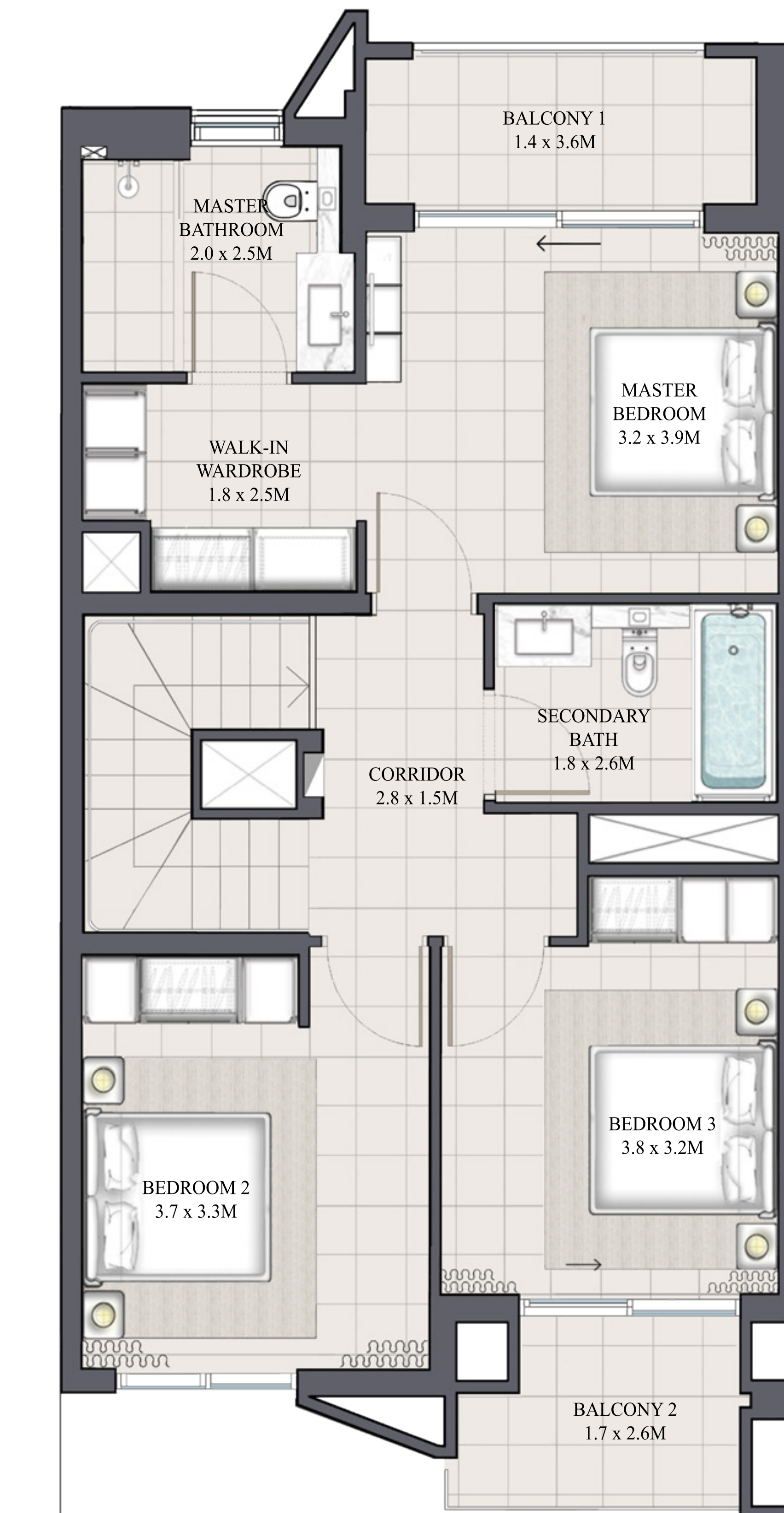

FIRST FLOOR

DLG

DUBAI LUXURY GUY

Instagram: @DUBAILUXURYGUY

Phone: +97150 100 5593

Phone: +97150 840 3520

FLOOR PLAN 1. All dimensions are in imperial and metric, and measured from finish to finish excluding construction tolerances. 2. All materials, dimensions, and drawings are approximate only. 3. Information is subject to change without notice, at developer's absolute discretion. 4. Actual area may vary from the stated area. 5. Drawings not to scale. 6. All images used are for illustrative purposes only and do not represent the actual size, features, specifications, fittings, and furnishings. 7. The developer reserves the right to make revisions / alterations, at its absolute discretion, without any liability whatsoever.

EMAAR

may

ARABIAN RANCHES III

ARIA TOWNHOUSE 3 BEDROOM 2

UNIT	TOTAL AREA	
6 PLEX - TH03	1983.89 SQFT	184.31 SQM
8 PLEX - TH03	1984.32 SQFT	184.35 SQM
8 PLEX - TH05	1984.32 SQFT	184.35 SQM

KEY PLAN

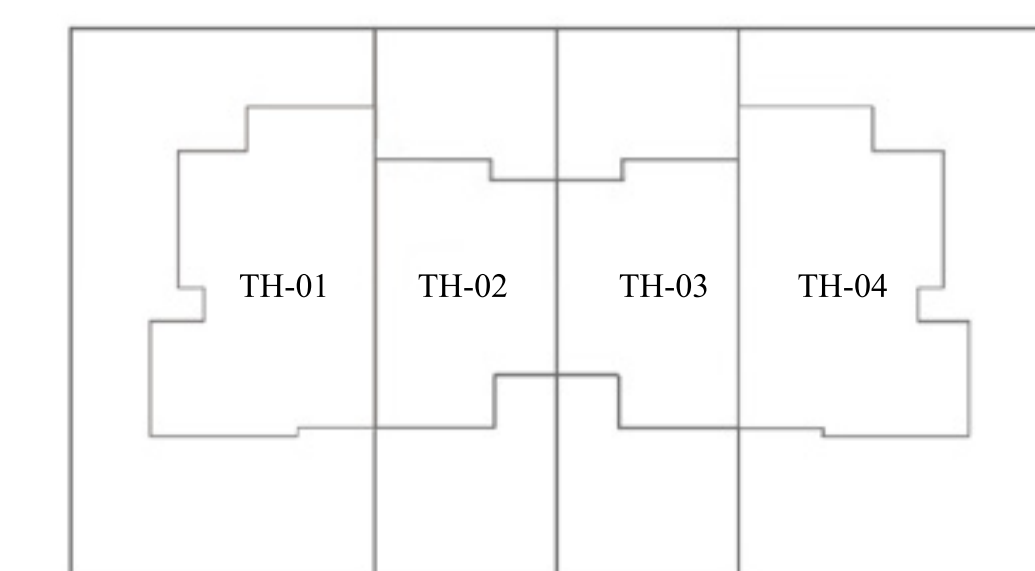

4 PLEX

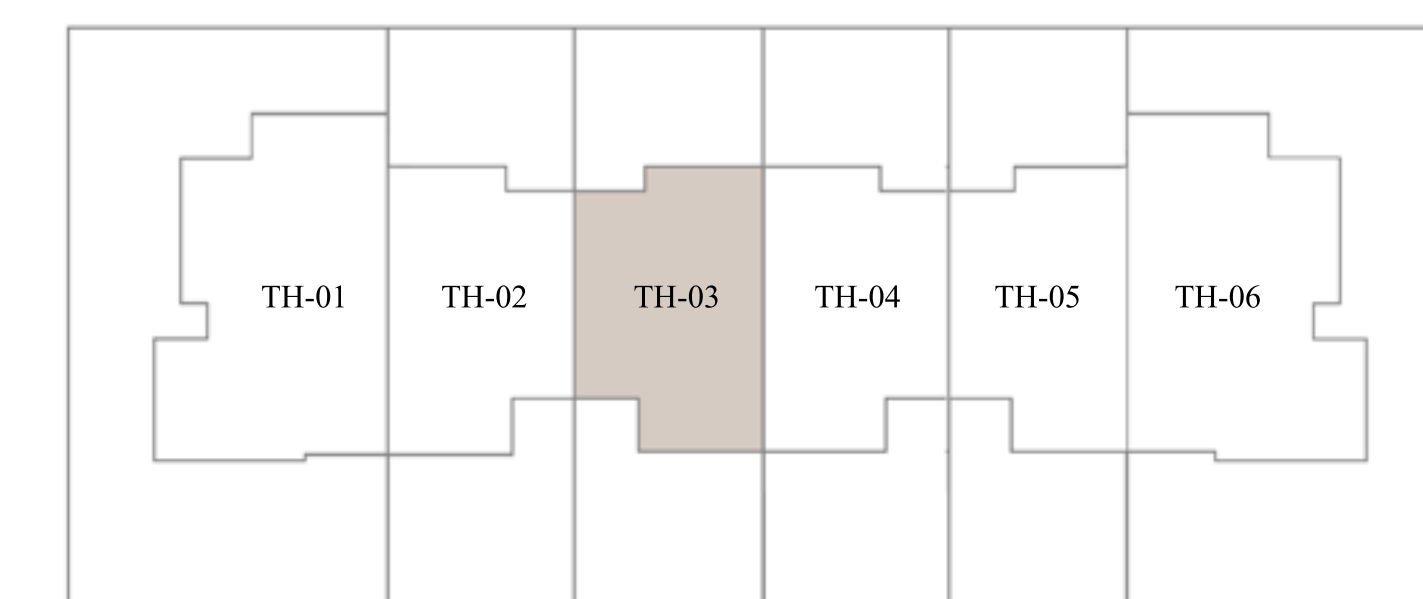

6 PLEX - TH03

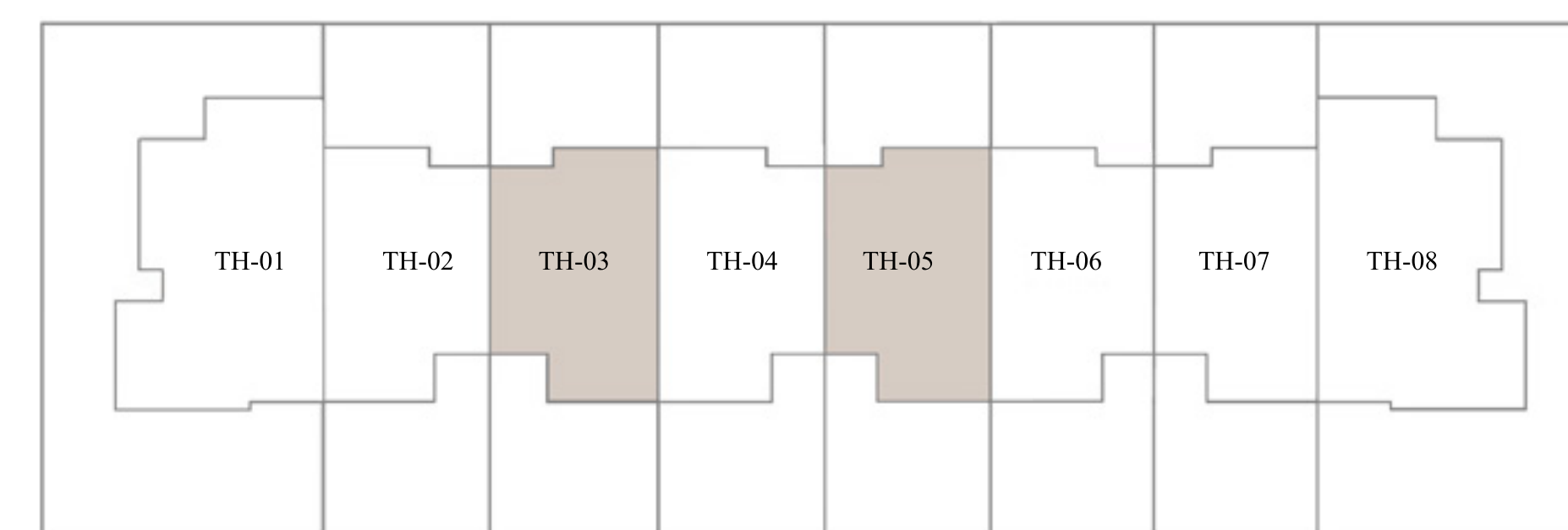

8 PLEX - TH03, TH05

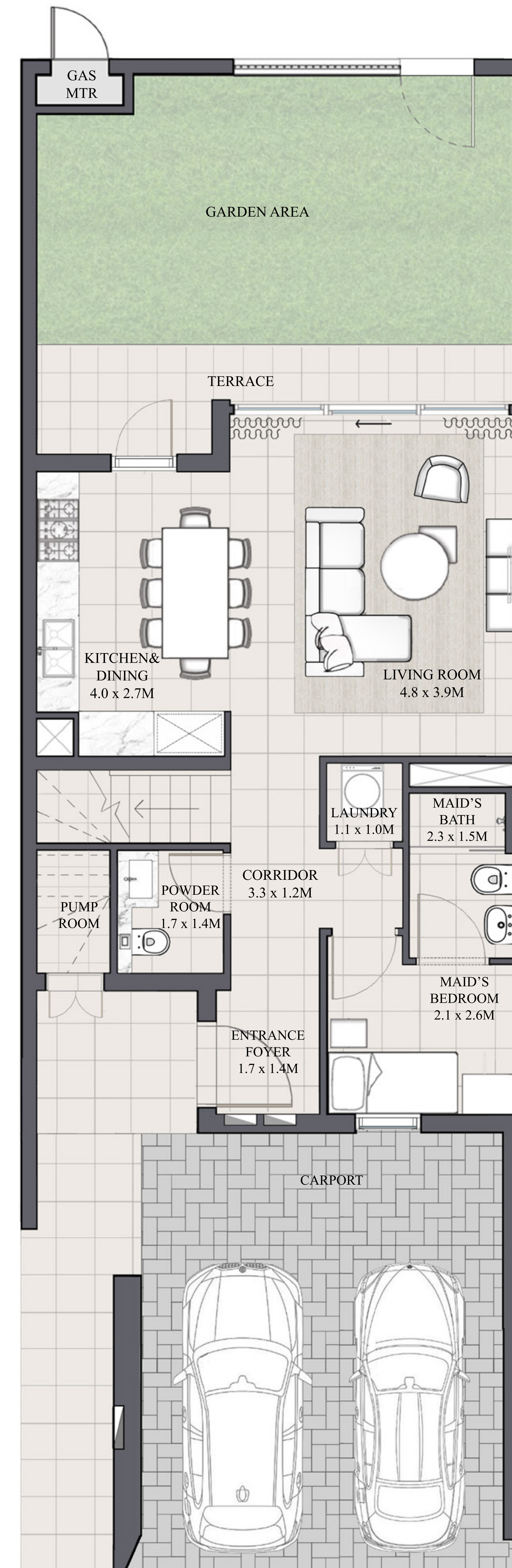

GROUND FLOOR

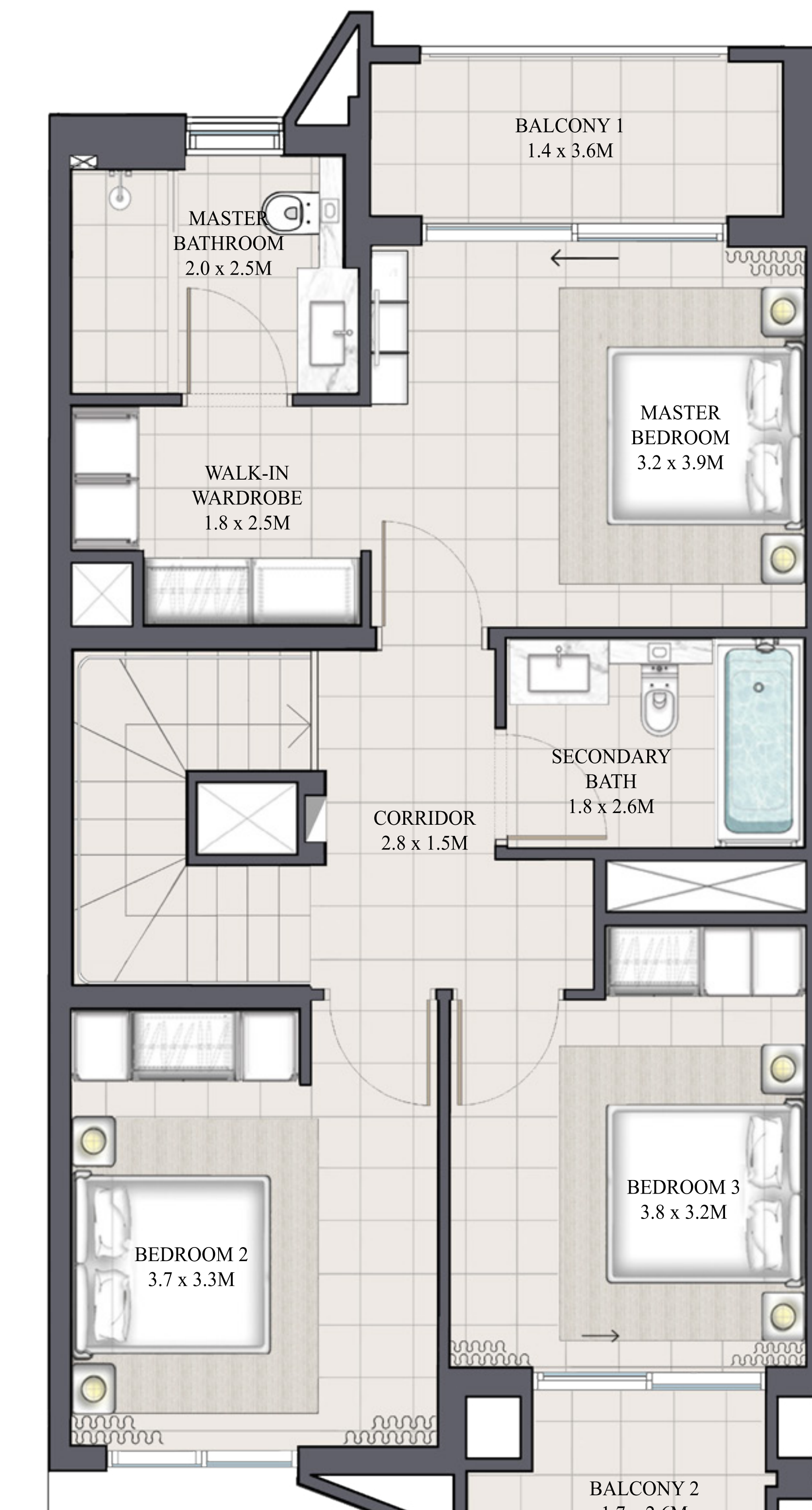

DLG

DUBAI LUXURY GUY

@DUBAILUXURYGUY

+97150 100 5593

+97150 840 3520

FLOOR PLAN 1. All dimensions are in imperial and metric, and measured from finish to finish excluding construction tolerances. 2. All materials, dimensions, and drawings are approximate only. 3. Information is subject to change without notice, at developer's absolute discretion. 4. Actual area may vary from the stated area. 5. Drawings not to scale. 6. All images used are for illustrative purposes only and do not represent the actual size, features, specifications, fittings, and furnishings. 7. The developer reserves the right to make revisions / alterations, at its absolute discretion, without any liability whatsoever.

EMAAR

may

ARABIAN RANCHES III

ARIA TOWNHOUSE 3 BEDROOM 2 M MIRRORED

UNIT	TOTAL AREA	
6 PLEX - TH04	1983.89 SQFT	184.31 SQM
8 PLEX - TH04	1984.32 SQFT	184.35 SQM
8 PLEX - TH06	1984.32 SQF	184.35 SQM

KEY PLAN

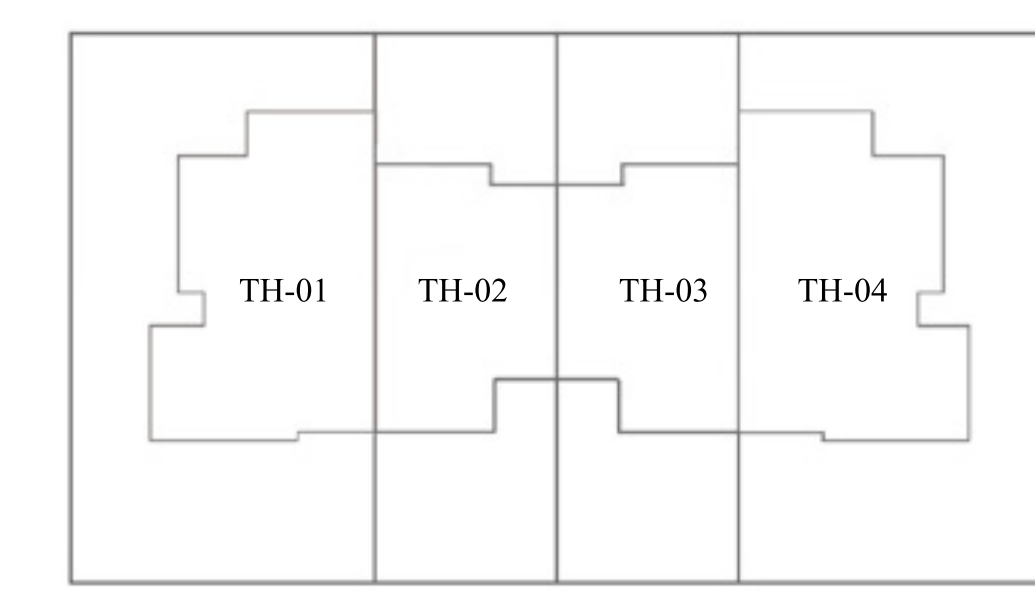

4 PLEX

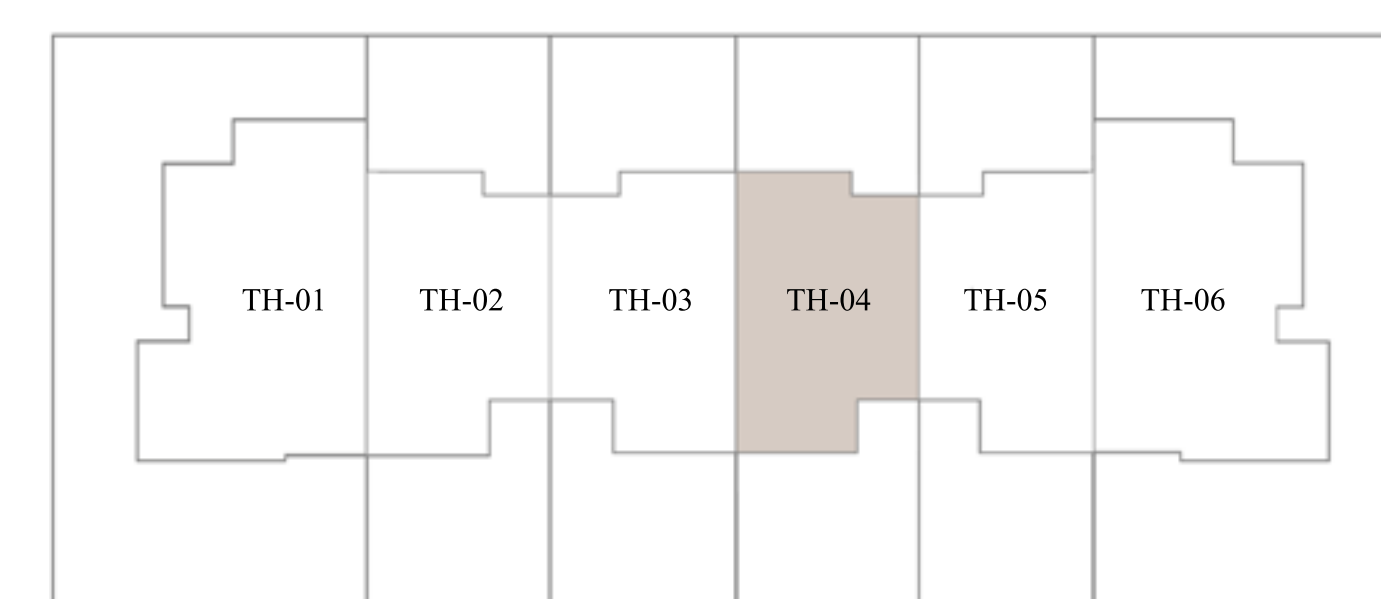

6 PLEX - TH04

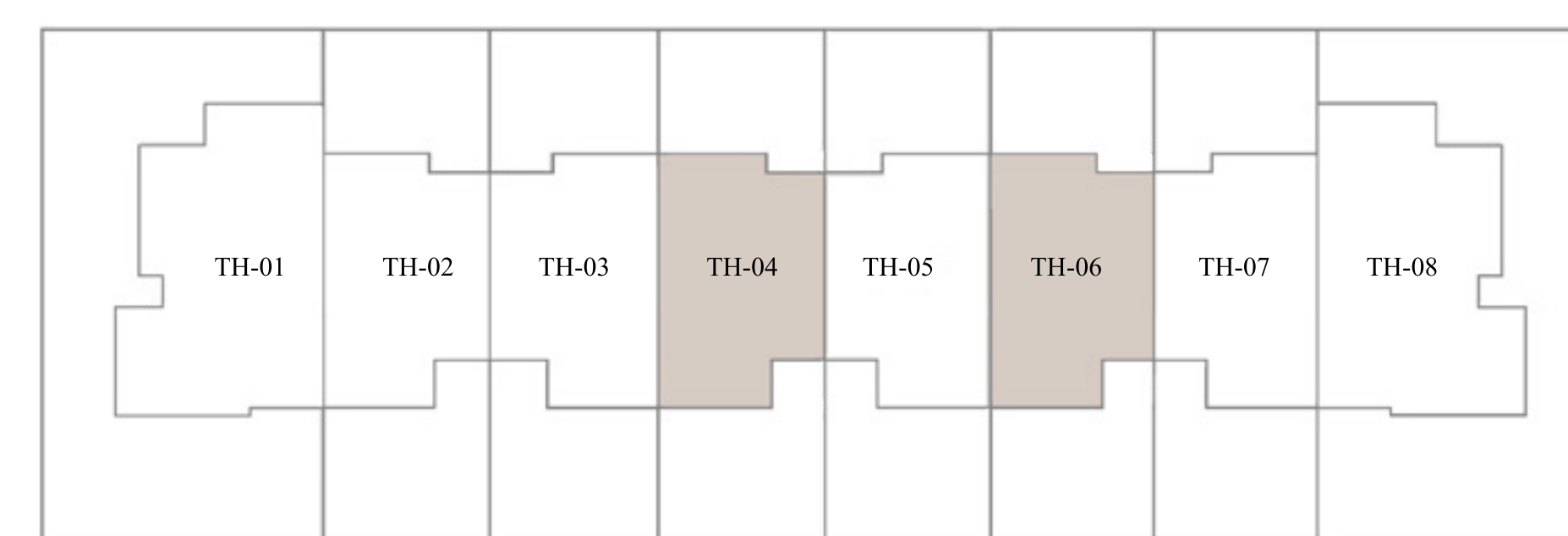

8 PLEX - TH04, TH06

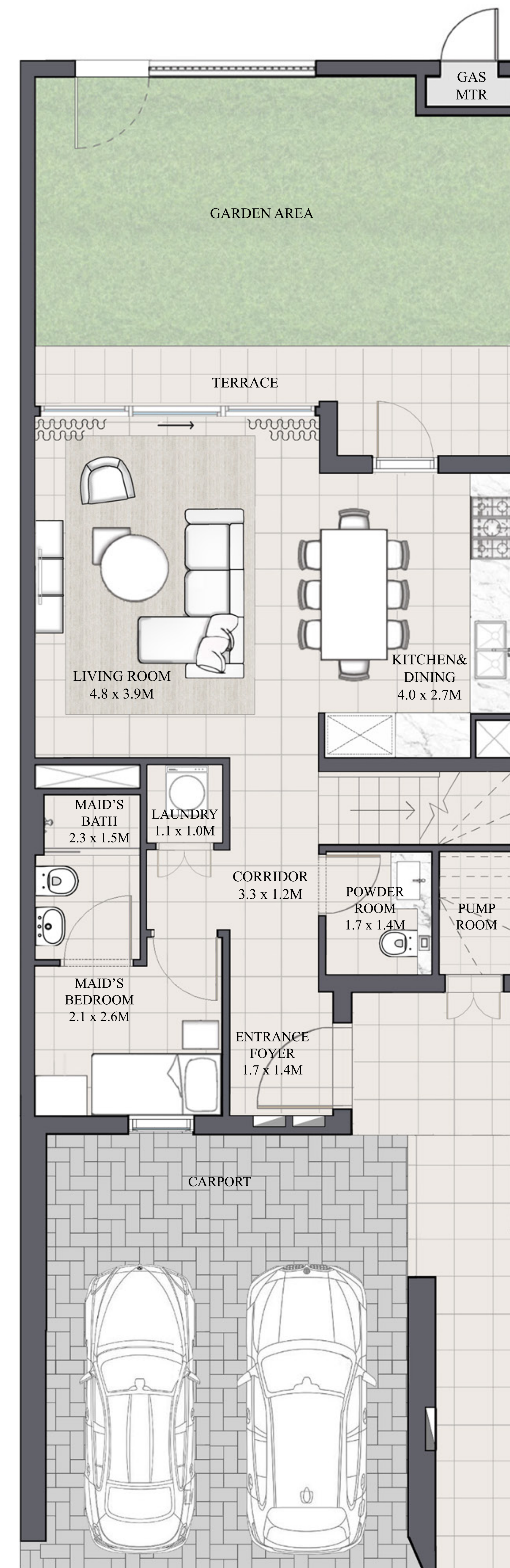

GROUND FLOOR

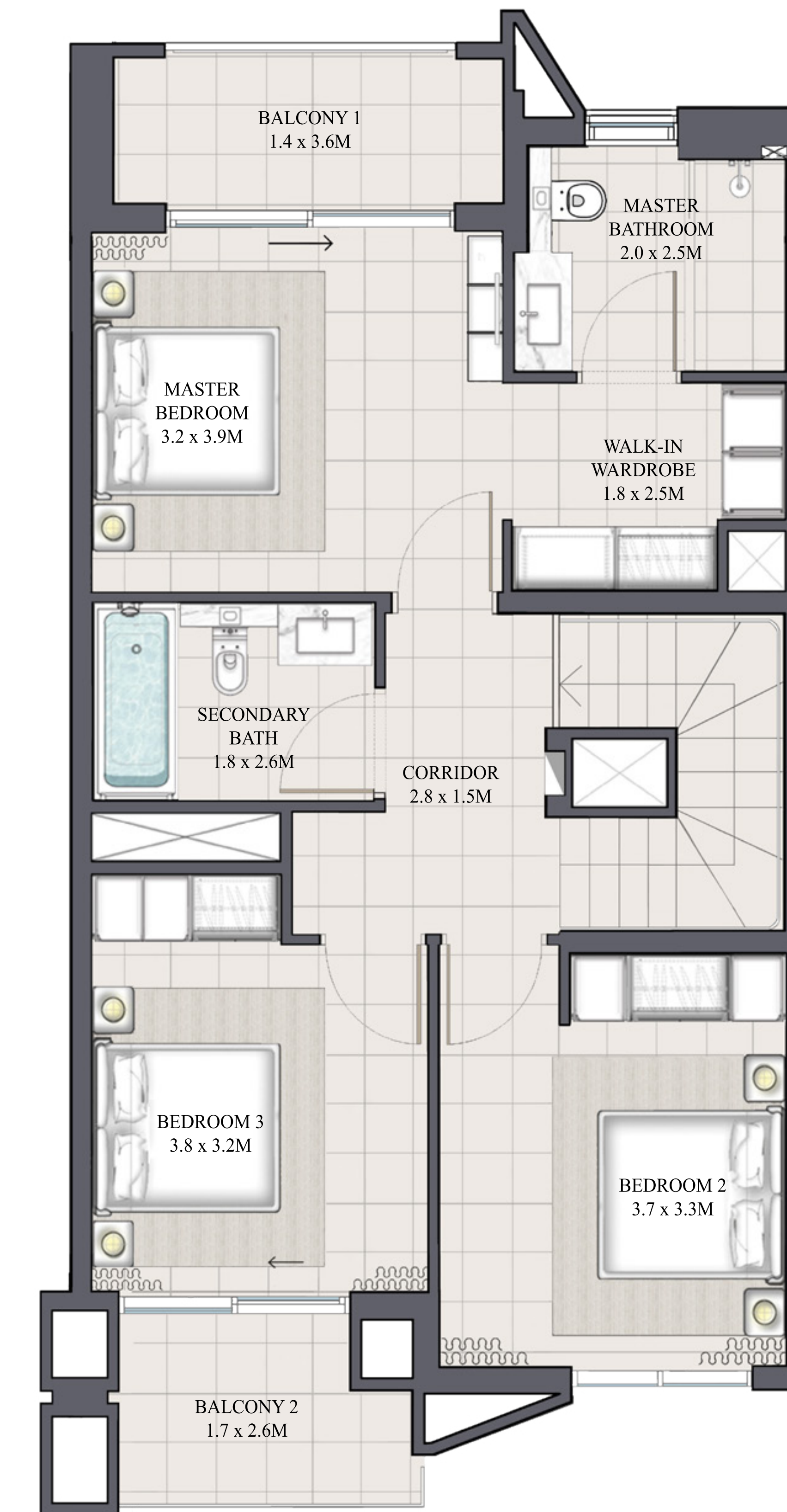

FIRST FLOOR

DLG
DUBAI LUXURY GUY

Instagram: @DUBAILUXURYGUY
 WhatsApp: +97150 100 5593
 Phone: +97150 840 3520

FLOOR PLAN 1. All dimensions are in imperial and metric, and measured from finish to finish excluding construction tolerances. 2. All materials, dimensions, and drawings are approximate only. 3. Information is subject to change without notice, at developer's absolute discretion. 4. Actual area may vary from the stated area. 5. Drawings not to scale. 6. All images used are for illustrative purposes only and do not represent the actual size, features, specifications, fittings, and furnishings. 7. The developer reserves the right to make revisions / alterations, at its absolute discretion, without any liability whatsoever.

ARABIAN RANCHES III

may

IRIS - FLOOR PLANS

DLG
DUBAI LUXURY GUY

 @DUBAILUXURYGUY

 +97150 100 5593

 +97150 840 3520

EMAAR

may

ARABIAN RANCHES III

IRIS TOWNHOUSE 4 BEDROOM 1

UNIT	TOTAL AREA	
4 PLEX - TH01		
6 PLEX - TH01	2452.23 SQFT	227.82 SQM
8 PLEX - TH01		

KEY PLAN

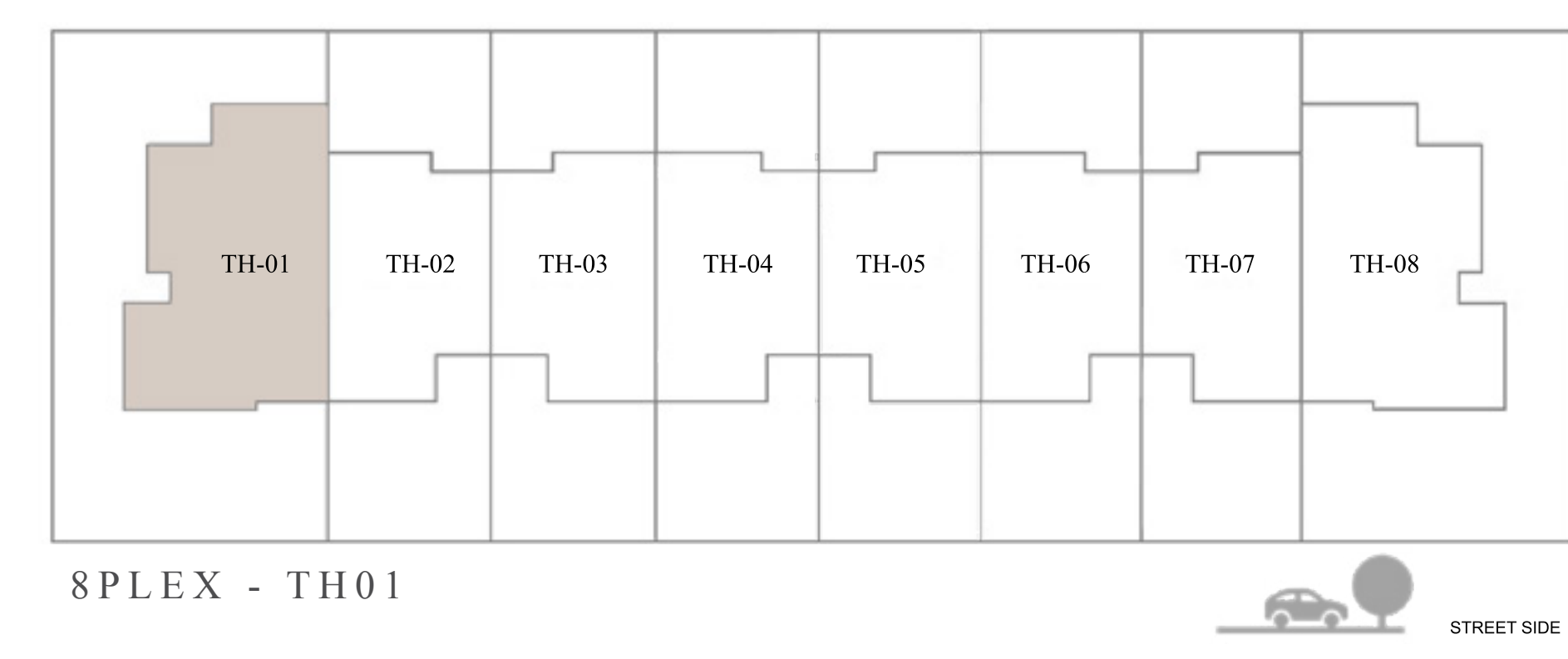
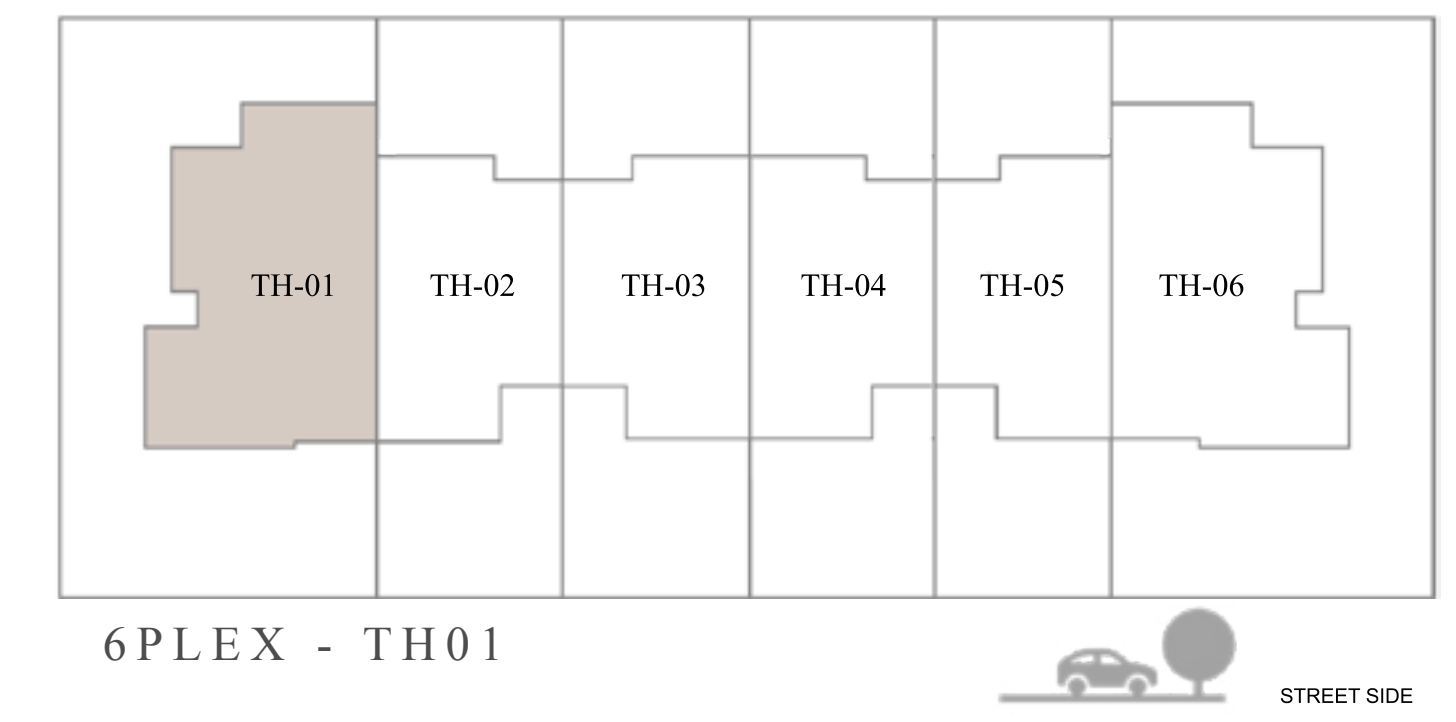
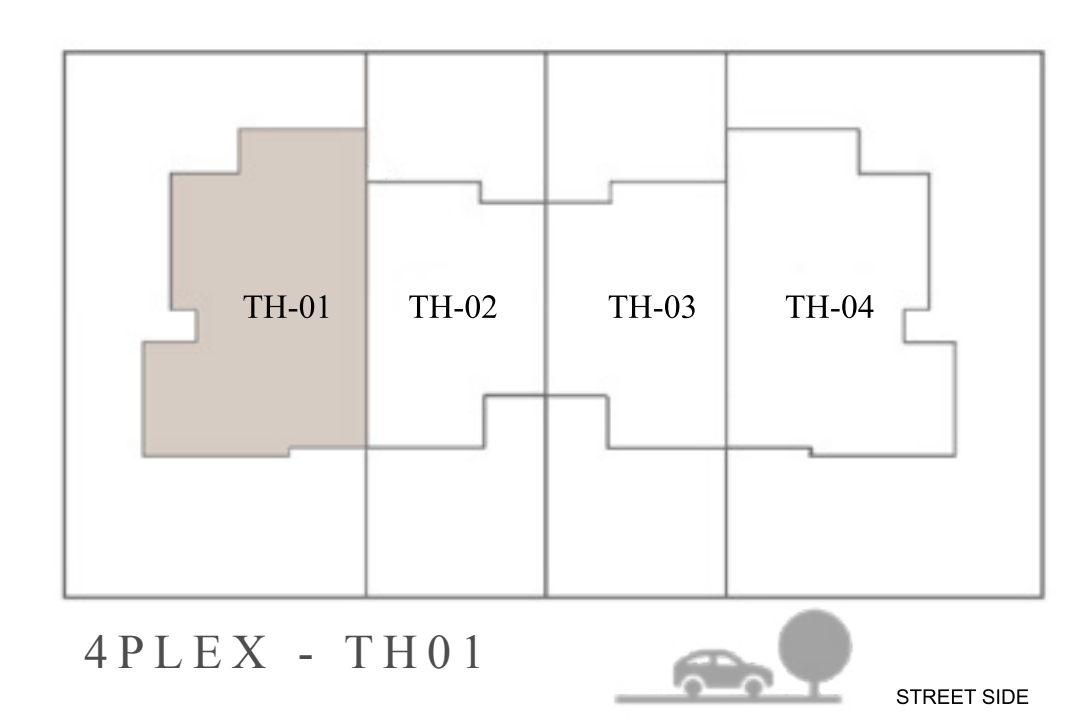

DLG
DUBAI LUXURY GUY

Instagram: @DUBAILUXURYGUY
 WhatsApp: +97150 100 5593
 Phone: +97150 840 3520



GROUND FLOOR

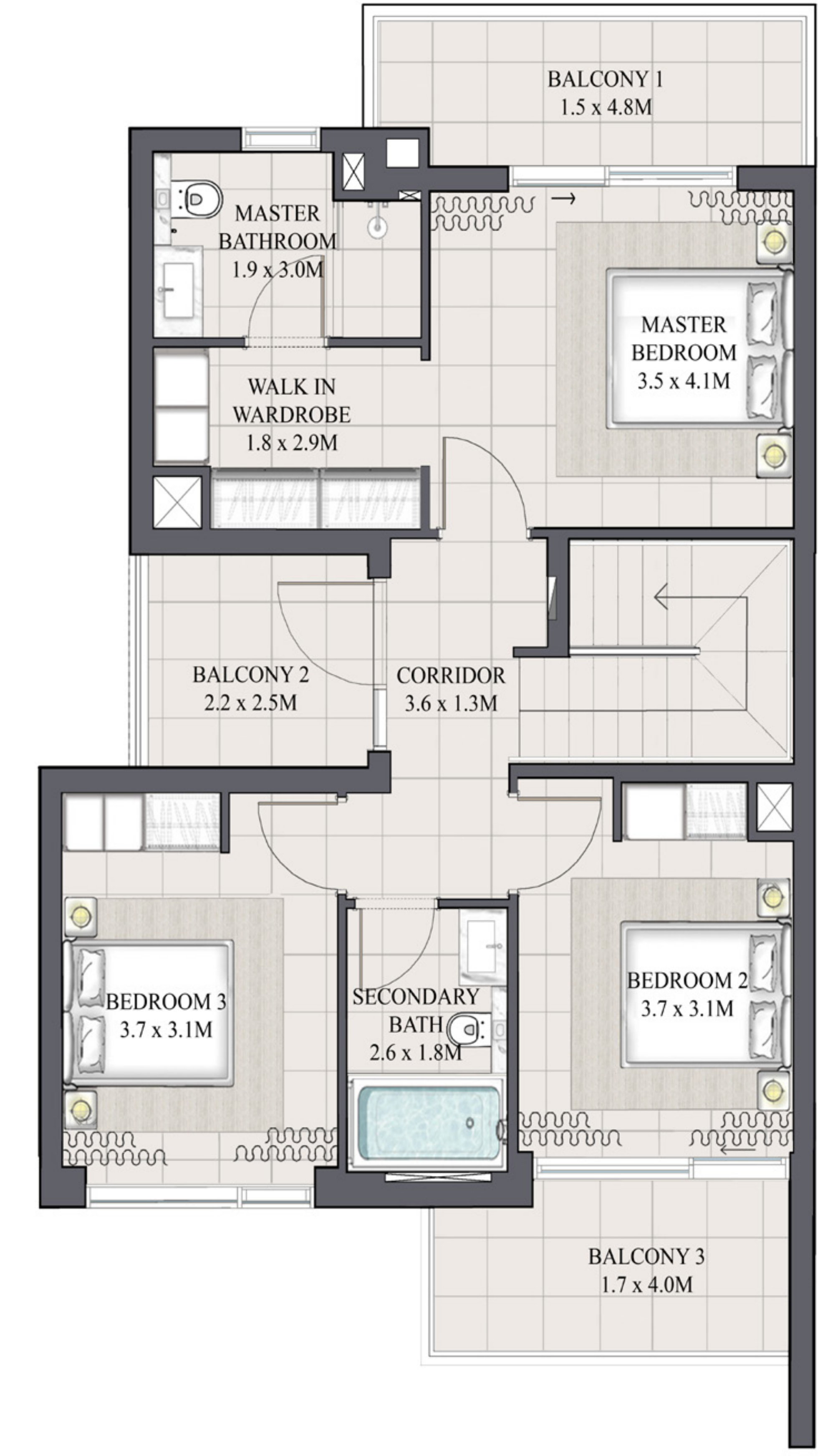

FIRST FLOOR

FLOOR PLAN 1. All dimensions are in imperial and metric, and measured from finish to finish excluding construction tolerances. 2. All materials, dimensions, and drawings are approximate only. 3. Information is subject to change without notice, at developer's absolute discretion. 4. Actual area may vary from the stated area. 5. Drawings not to scale. 6. All images used are for illustrative purposes only and do not represent the actual size, features, specifications, fittings, and furnishings. 7. The developer reserves the right to make revisions / alterations, at it's absolute discretion, without any liability whatsoever.

may

ARABIAN RANCHES III

IRIS TOWNHOUSE 4 BEDROOM 1M MIRRORED

UNIT	TOTAL AREA	
4 PLEX - TH04		
6 PLEX - TH06	2452.23 SQFT	227.82 SQM
8 PLEX - TH08		

KEY PLAN

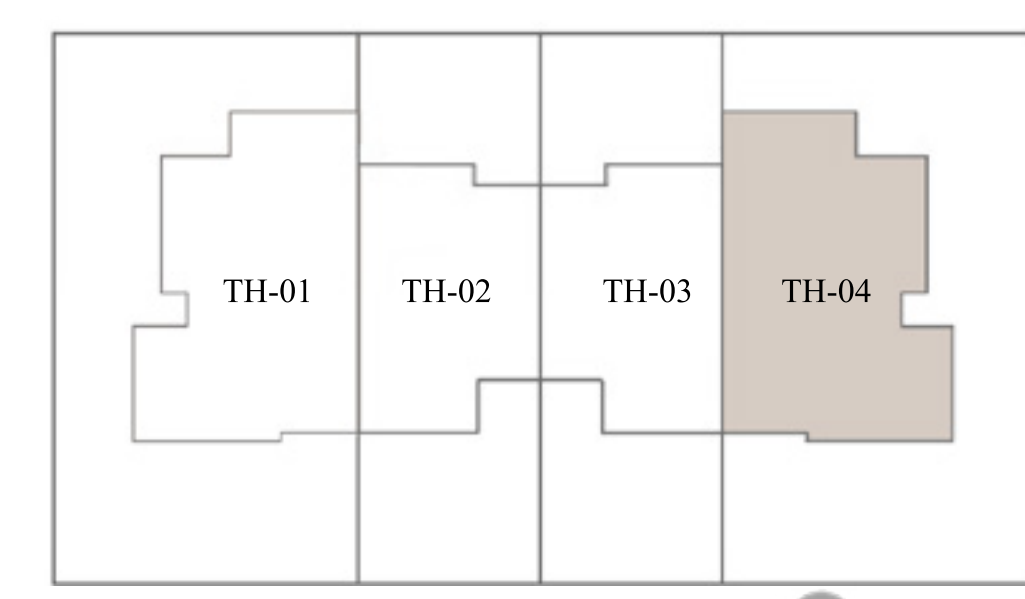

4 PLEX - TH04

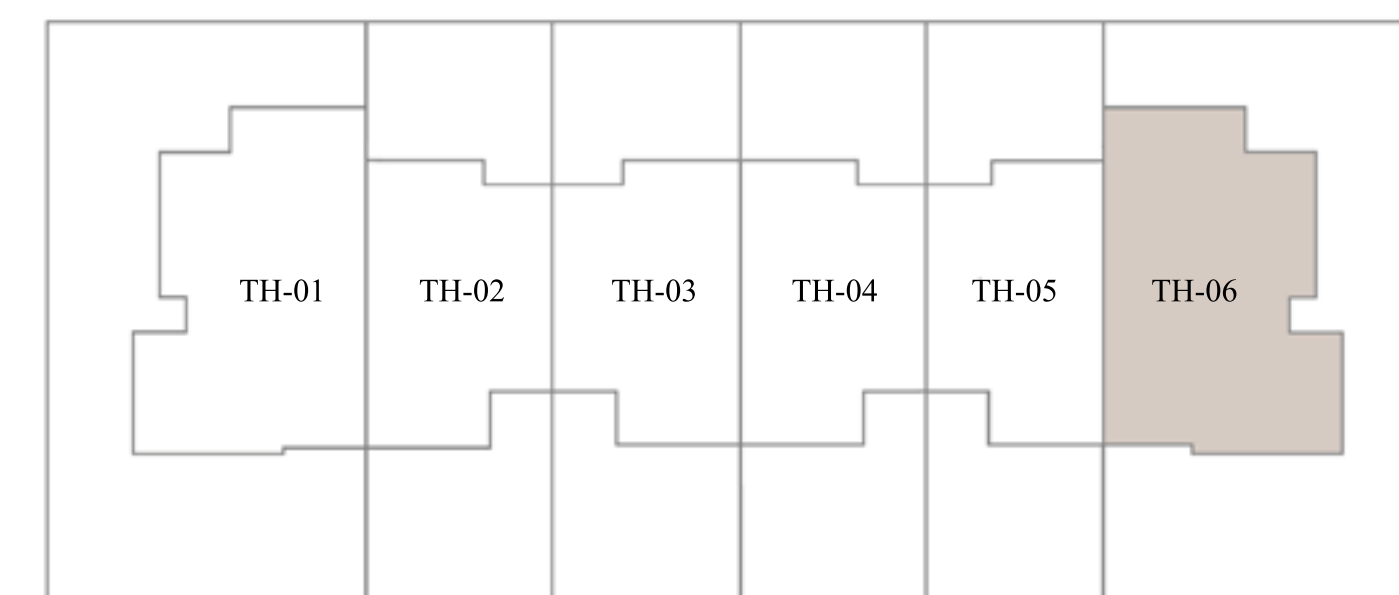

6 PLEX - TH06

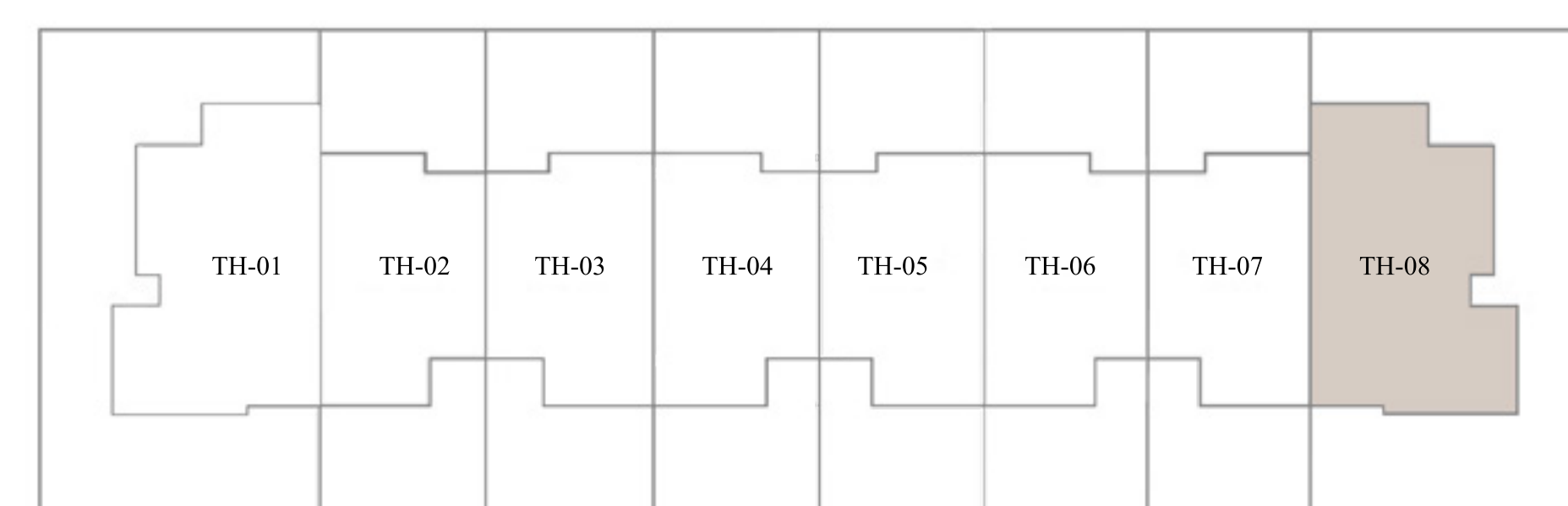

8 PLEX - TH08

DLG

DUBAI LUXURY GUY

[@DUBAILUXURYGUY](https://www.instagram.com/dubailuxuryguy)
 +97150 100 5593
 +97150 840 3520



GROUND FLOOR

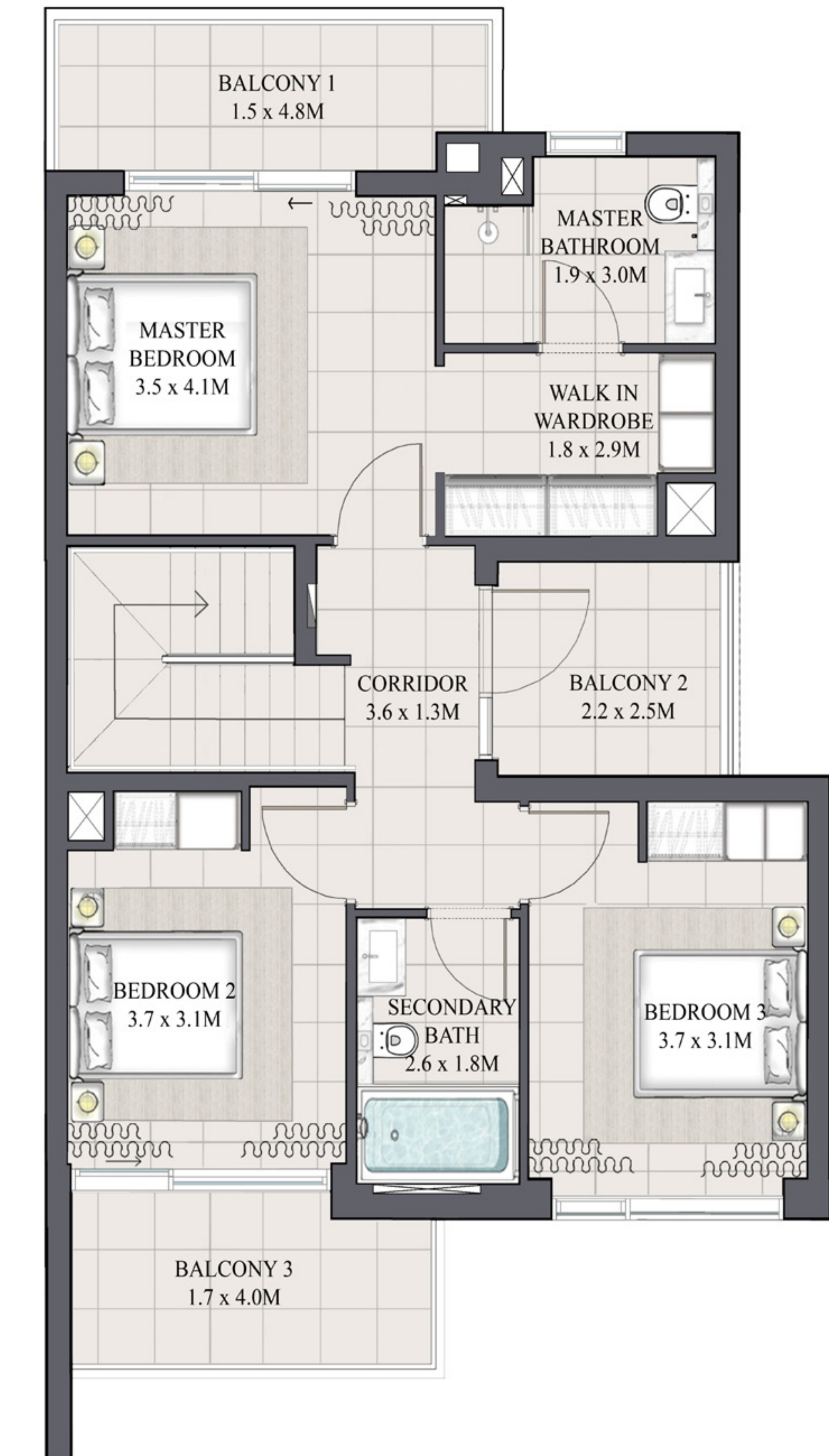

FIRST FLOOR

FLOOR PLAN 1. All dimensions are in imperial and metric, and measured from finish to finish excluding construction tolerances. 2. All materials, dimensions, and drawings are approximate only. 3. Information is subject to change without notice, at developer's absolute discretion. 4. Actual area may vary from the stated area. 5. Drawings not to scale. 6. All images used are for illustrative purposes only and do not represent the actual size, features, specifications, fittings, and furnishings. 7. The developer reserves the right to make revisions / alterations, at it's absolute discretion, without any liability whatsoever.

may

ARABIAN RANCHES III

IRIS TOWNHOUSE 3 BEDROOM 1

UNIT	TOTAL AREA	
4 PLEX - TH02		
6 PLEX - TH02	2035.35 SQFT	189.09 SQM
8 PLEX - TH02		

KEY PLAN

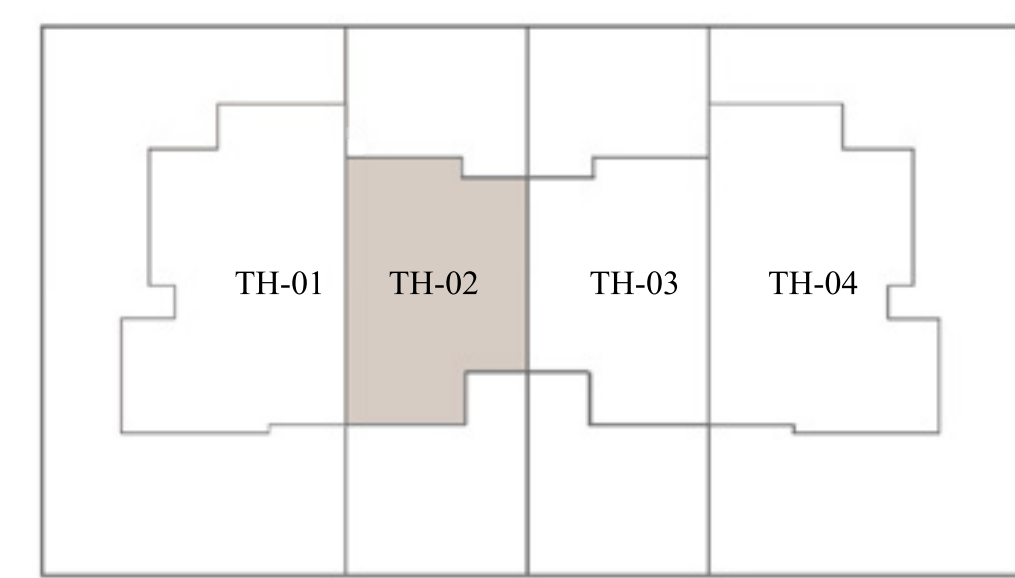

4 PLEX - TH02

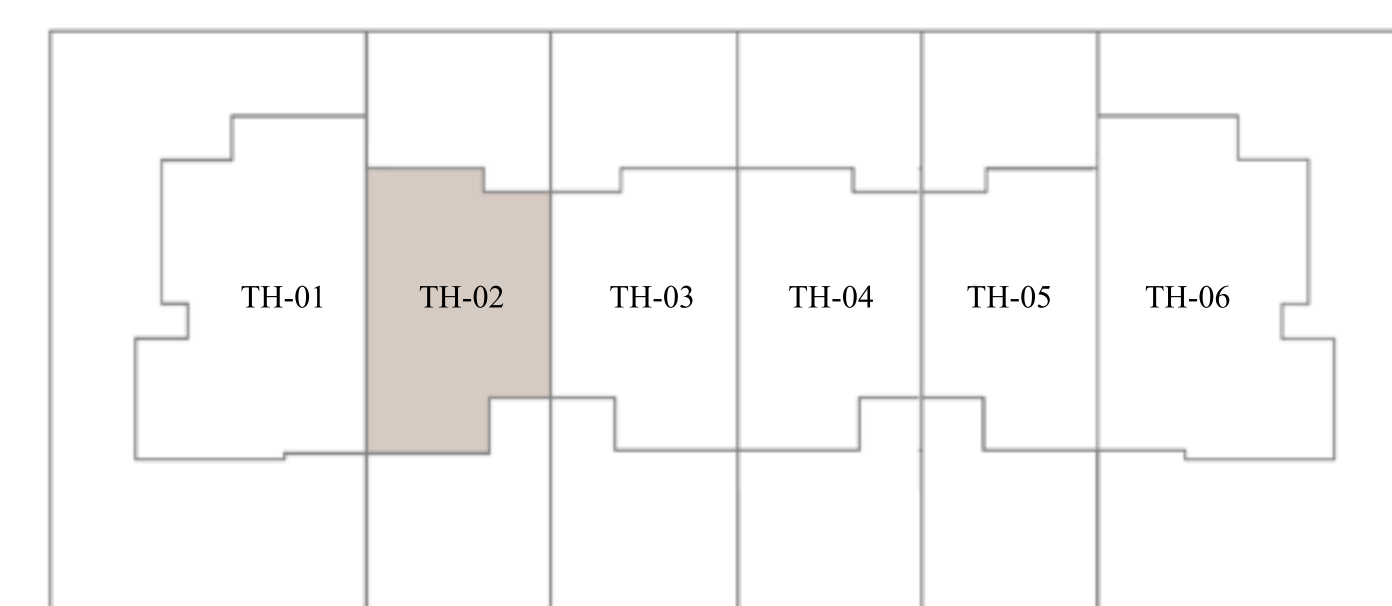

6 PLEX - TH02

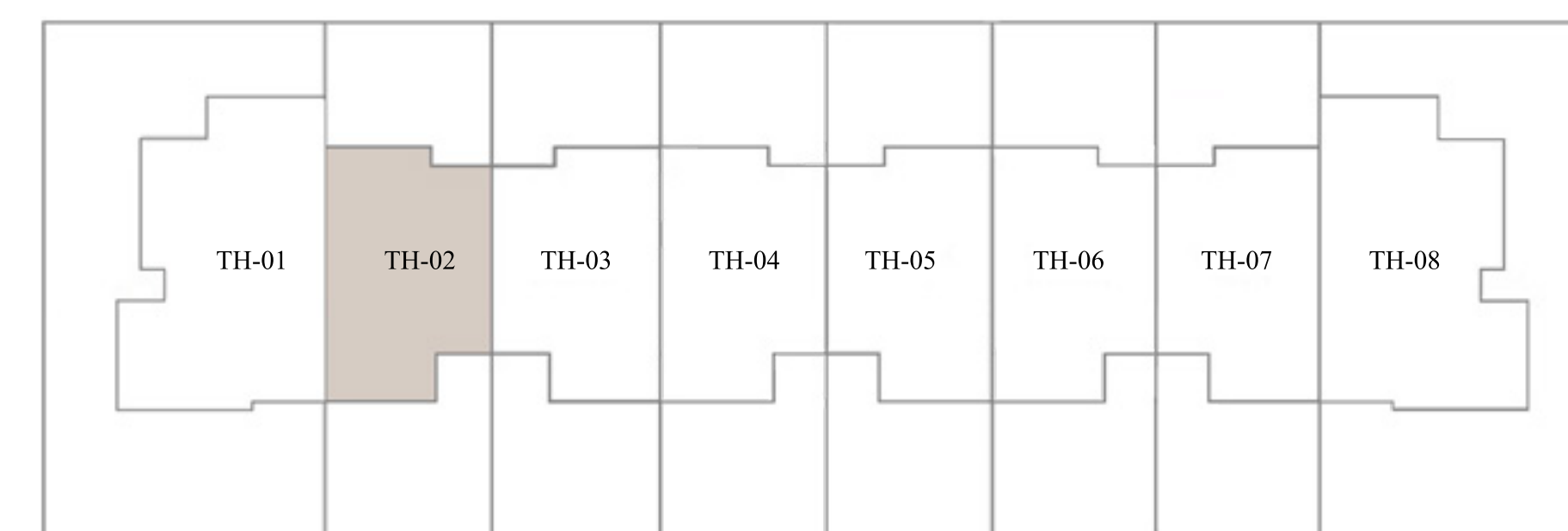

8 PLEX - TH02

DLG
DUBAI LUXURY GUY

@DUBAILUXURYGUY
 +97150 100 5593
 +97150 840 3520

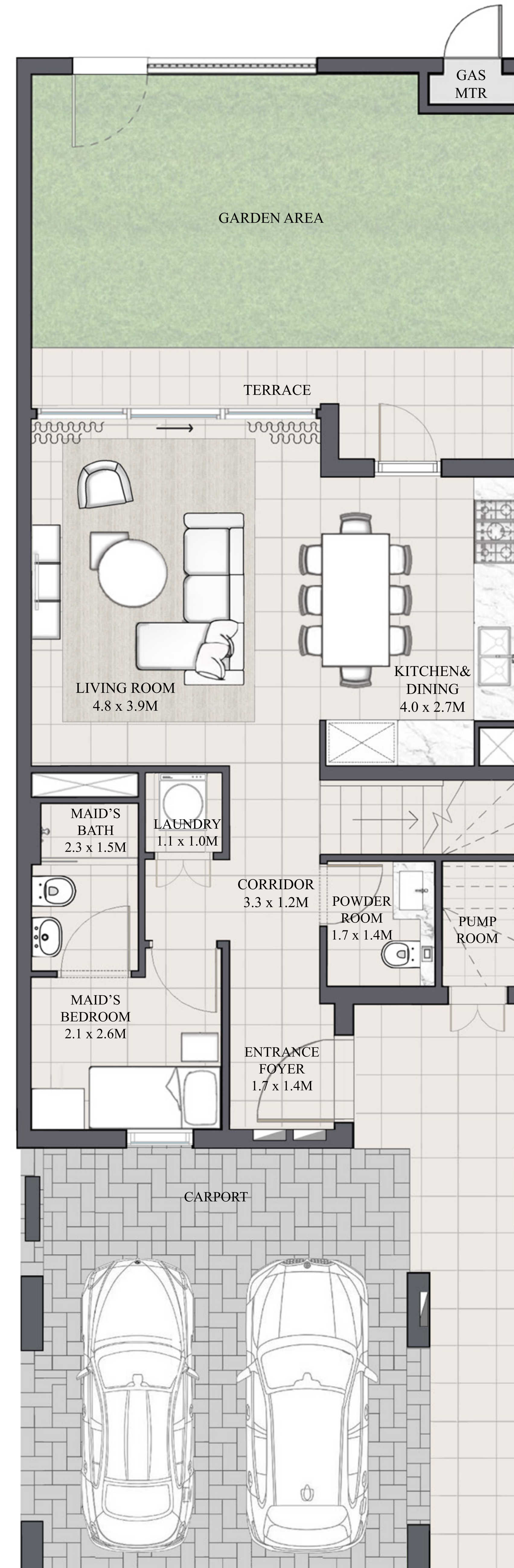

GROUND FLOOR

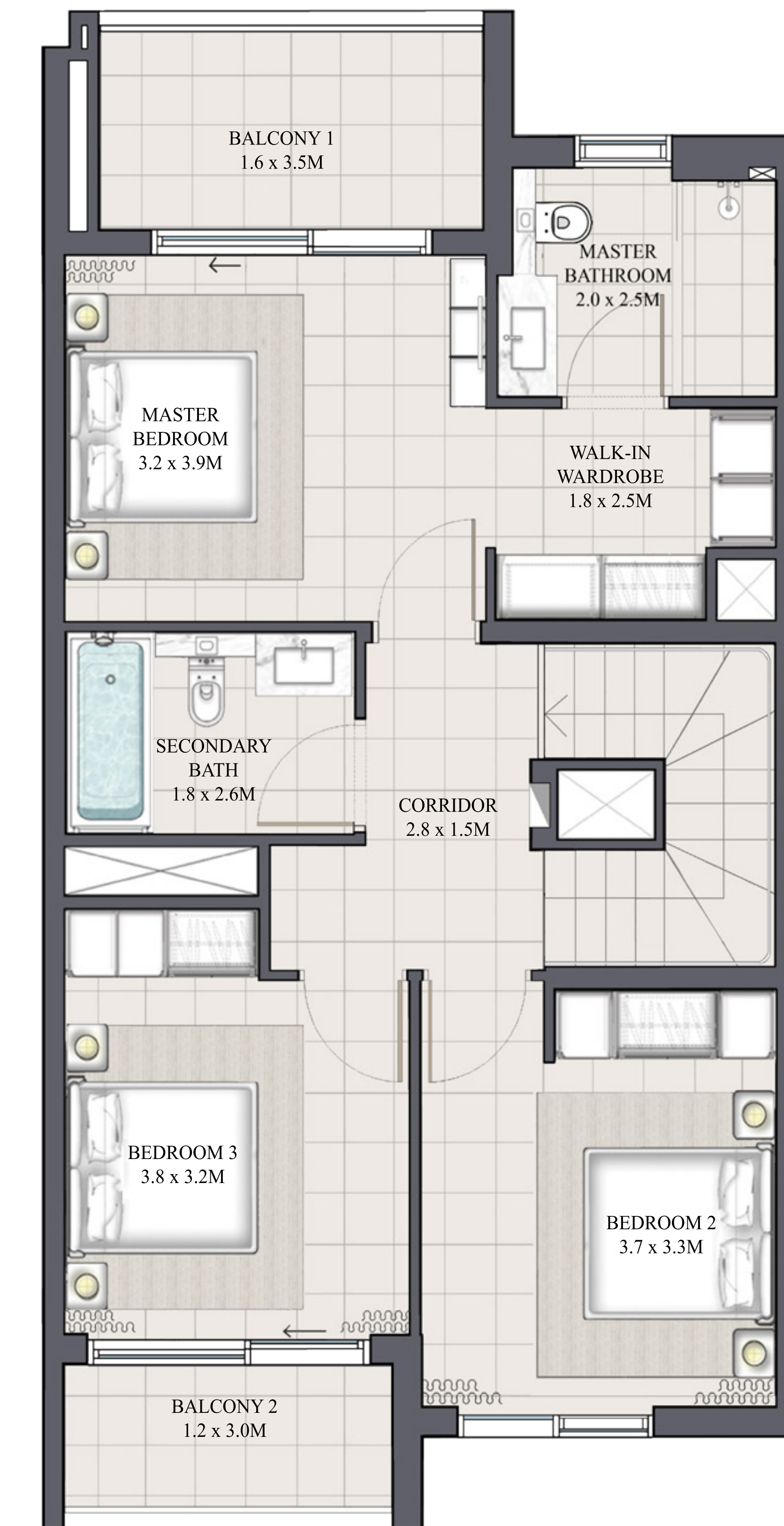

FIRST FLOOR

FLOOR PLAN 1. All dimensions are in imperial and metric, and measured from finish to finish excluding construction tolerances. 2. All materials, dimensions, and drawings are approximate only. 3. Information is subject to change without notice, at developer's absolute discretion. 4. Actual area may vary from the stated area. 5. Drawings not to scale. 6. All images used are for illustrative purposes only and do not represent the actual size, features, specifications, fittings, and furnishings. 7. The developer reserves the right to make revisions / alterations, at its absolute discretion, without any liability whatsoever.

may

ARABIAN RANCHES III

IRIS TOWNHOUSE 3 BEDROOM 1M MIRRORED

UNIT	TOTAL AREA	
4 PLEX - TH03		
6 PLEX - TH05	2035.35 SQFT	189.09 SQM
8 PLEX - TH07		

KEY PLAN

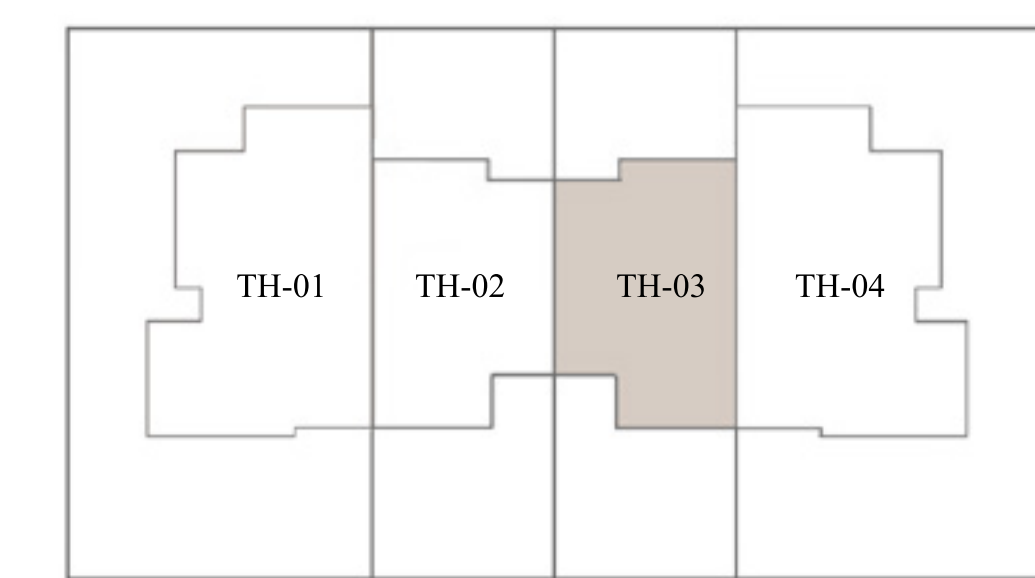

4 PLEX - TH03

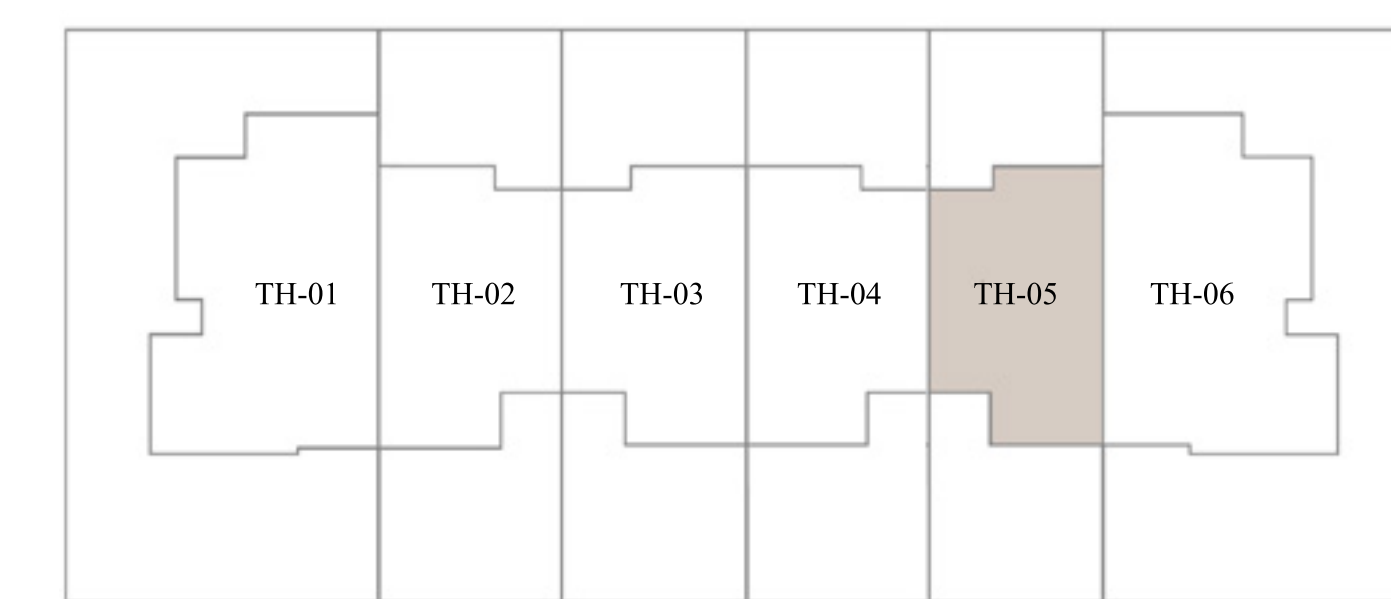

6 PLEX - TH05

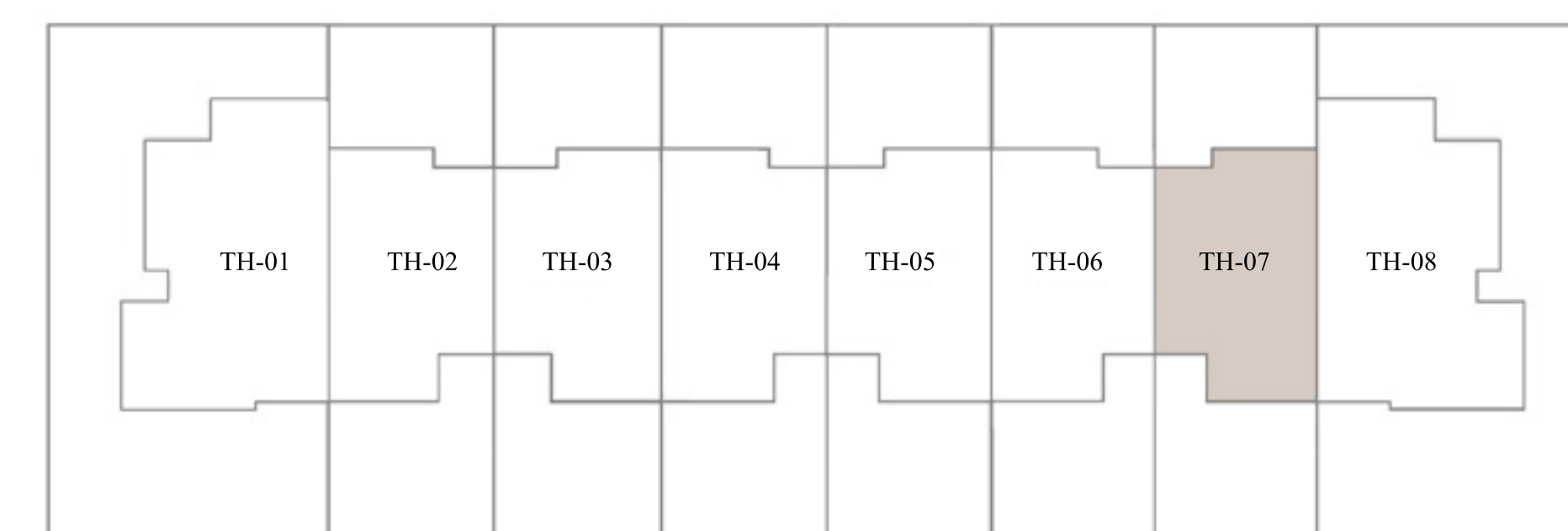

8 PLEX - TH07

DLG
DUBAI LUXURY GUY

Instagram: @DUBAILUXURYGUY
Phone: +97150 100 5593
Phone: +97150 840 3520



GROUND FLOOR

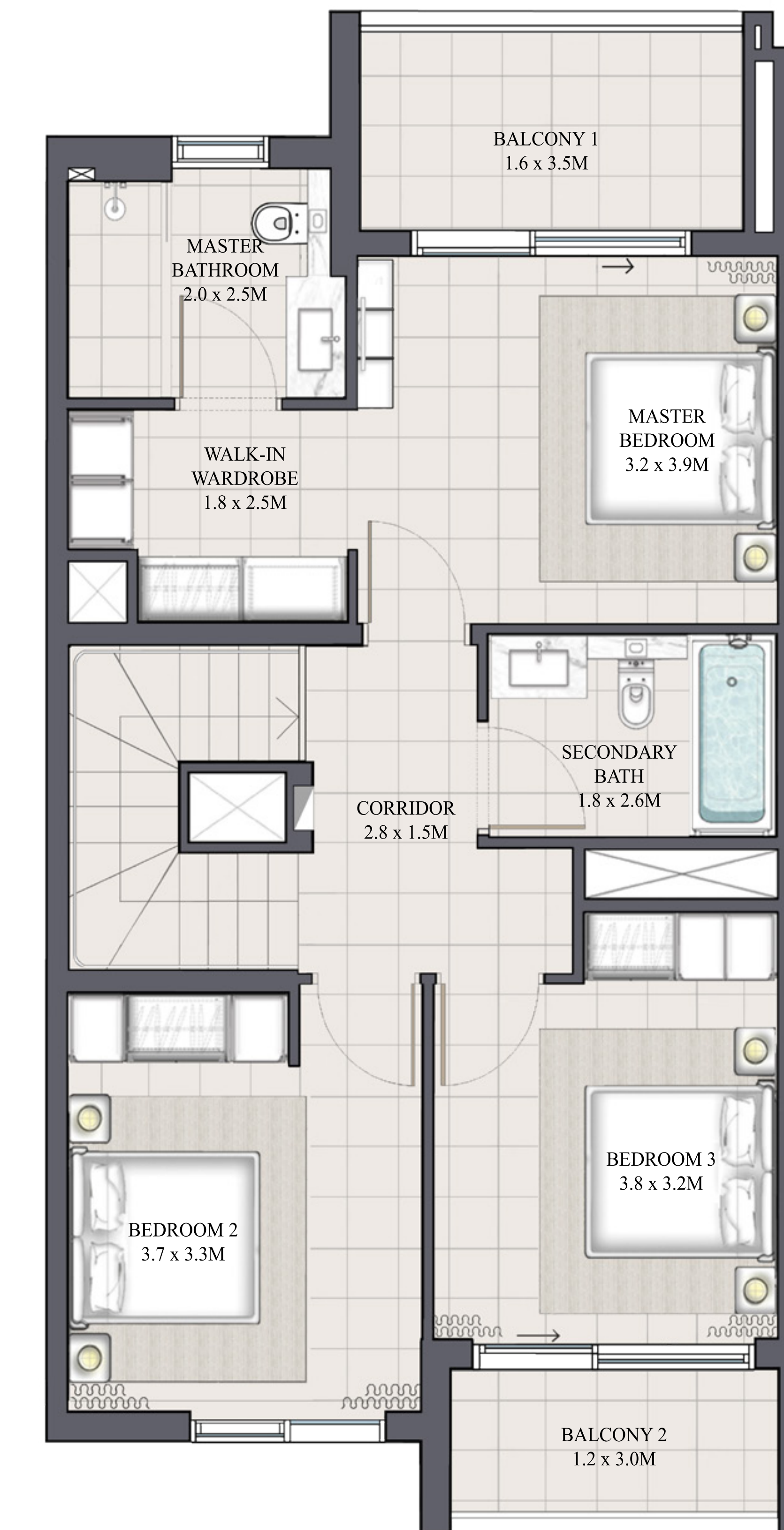

FIRST FLOOR

FLOOR PLAN 1. All dimensions are in imperial and metric, and measured from finish to finish excluding construction tolerances. 2. All materials, dimensions, and drawings are approximate only. 3. Information is subject to change without notice, at developer's absolute discretion. 4. Actual area may vary from the stated area. 5. Drawings not to scale. 6. All images used are for illustrative purposes only and do not represent the actual size, features, specifications, fittings, and furnishings. 7. The developer reserves the right to make revisions / alterations, at it's absolute discretion, without any liability whatsoever.

may

ARABIAN RANCHES III

IRIS TOWNHOUSE 3 BEDROOM 2

UNIT	TOTAL AREA	
6 PLEX - TH03		
8 PLEX - TH03	2032.98 SQFT	188.87 SQM
8 PLEX - TH05		

KEY PLAN

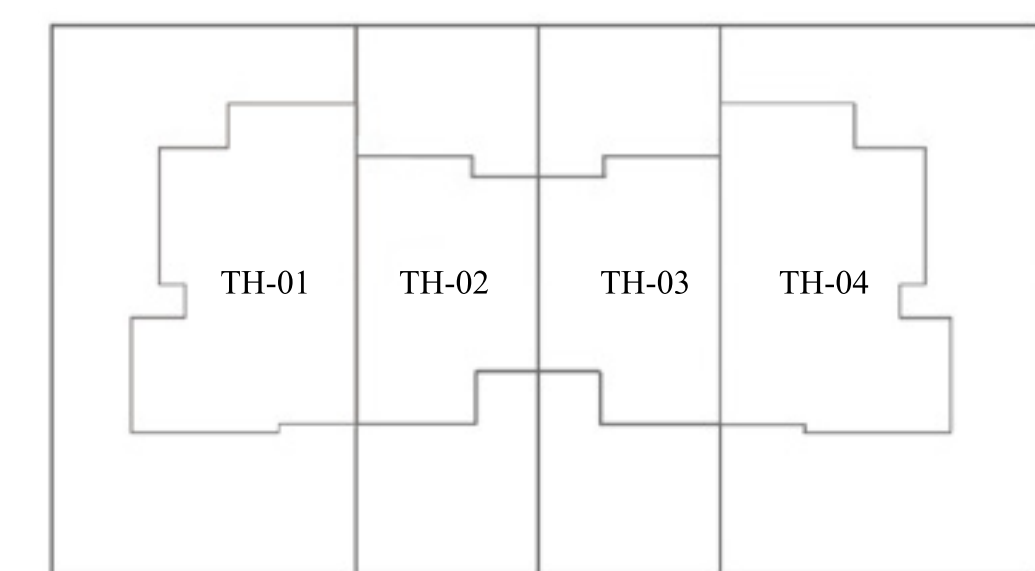

4 PLEX

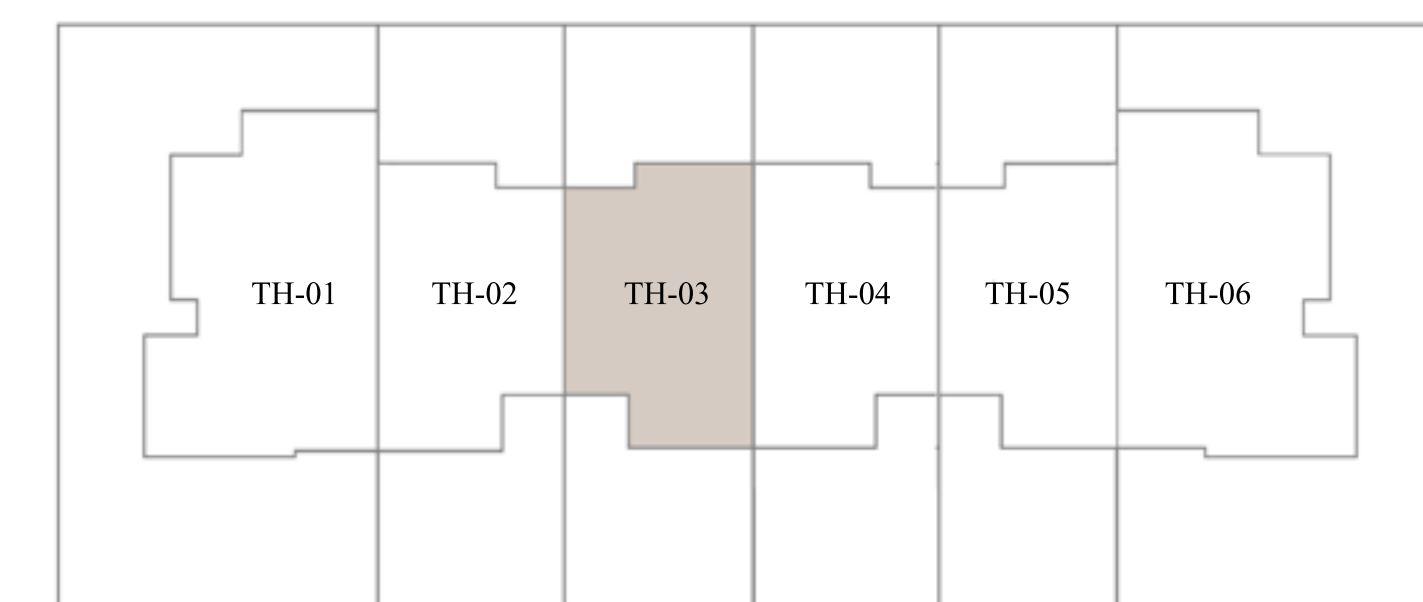

6 PLEX - TH03

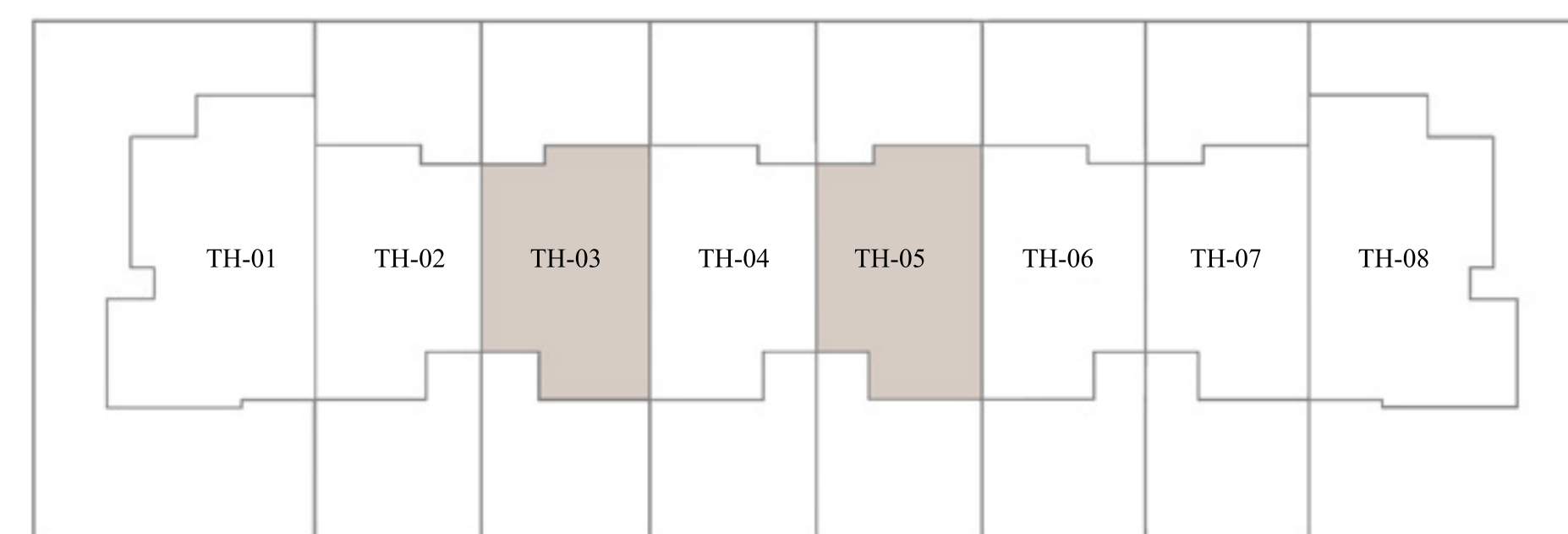

8 PLEX - TH03, TH05

DLG
DUBAI LUXURY GUY

@DUBAILUXURYGUY
 +97150 100 5593
 +97150 840 3520

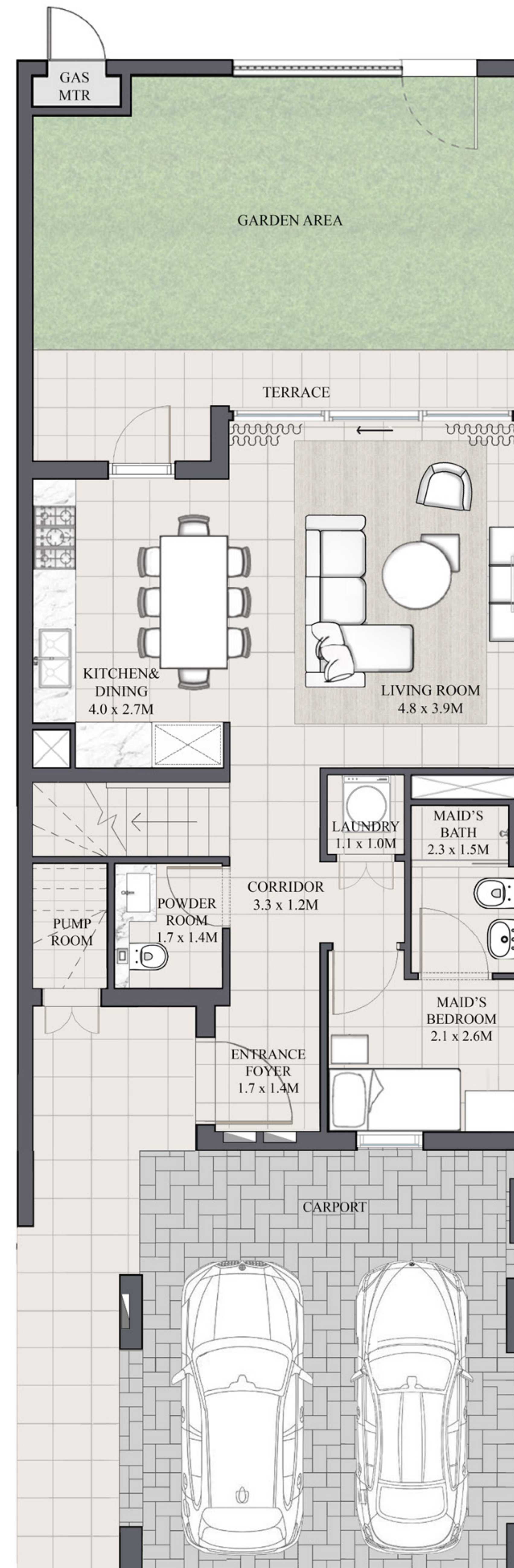

GROUND FLOOR

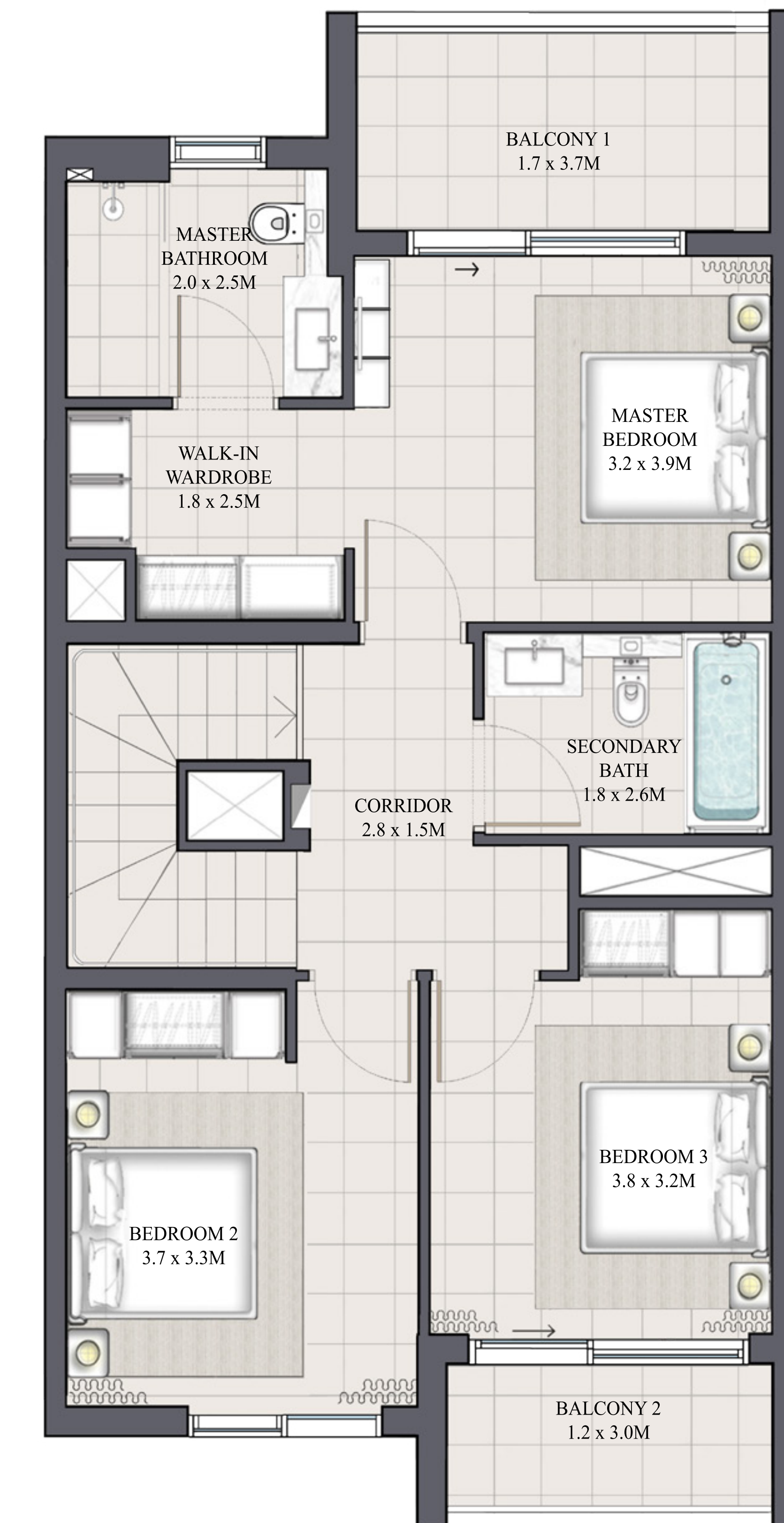

FIRST FLOOR

FLOOR PLAN 1. All dimensions are in imperial and metric, and measured from finish to finish excluding construction tolerances. 2. All materials, dimensions, and drawings are approximate only. 3. Information is subject to change without notice, at developer's absolute discretion. 4. Actual area may vary from the stated area. 5. Drawings not to scale. 6. All images used are for illustrative purposes only and do not represent the actual size, features, specifications, fittings, and furnishings. 7. The developer reserves the right to make revisions / alterations, at its absolute discretion, without any liability whatsoever.

may

ARABIAN RANCHES III

IRIS TOWNHOUSE 3 BEDROOM 2M

UNIT	TOTAL AREA	
6 PLEX - TH04		
8 PLEX - TH04	2032.98 SQFT	188.87 SQM
8 PLEX - TH06		

KEY PLAN

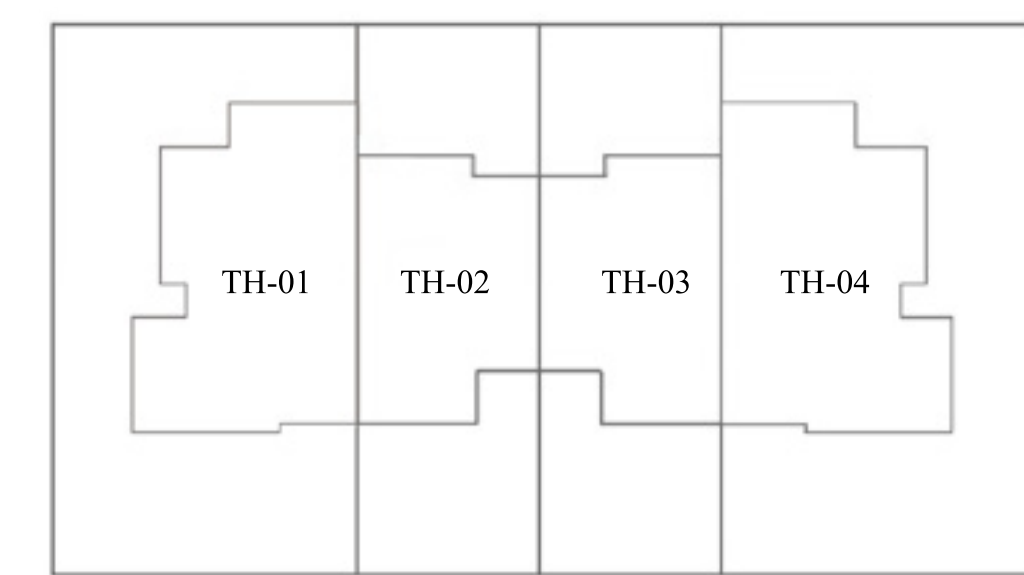

4 PLEX

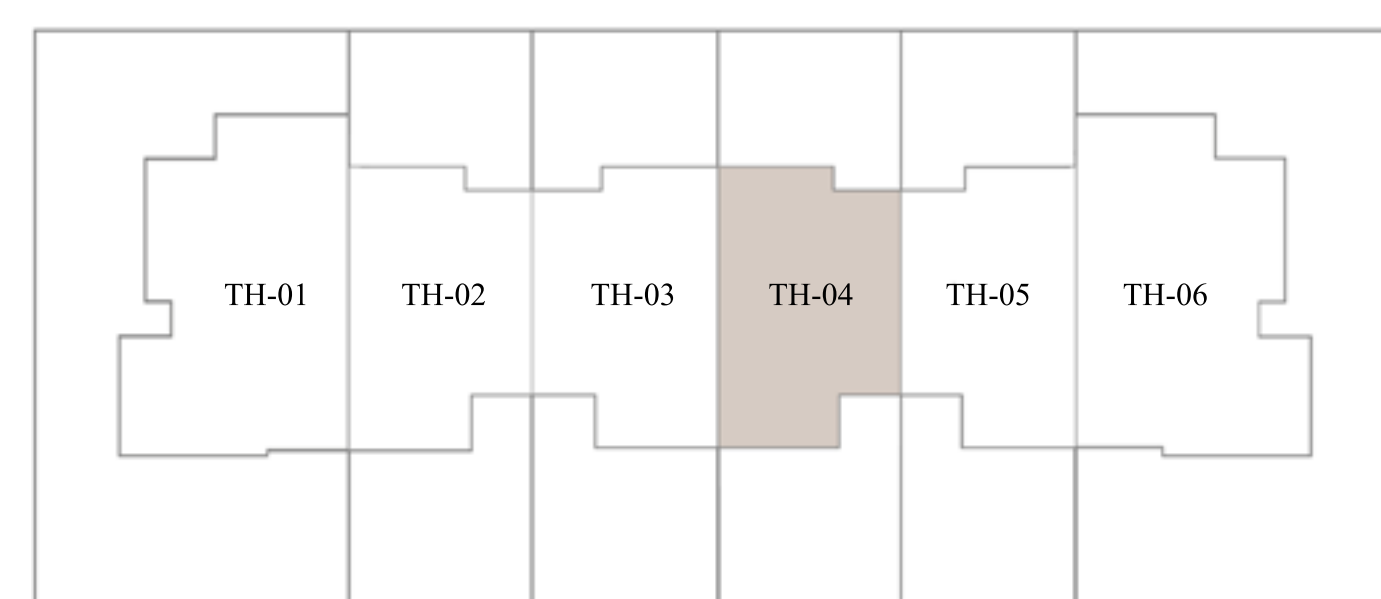

6 PLEX - TH04

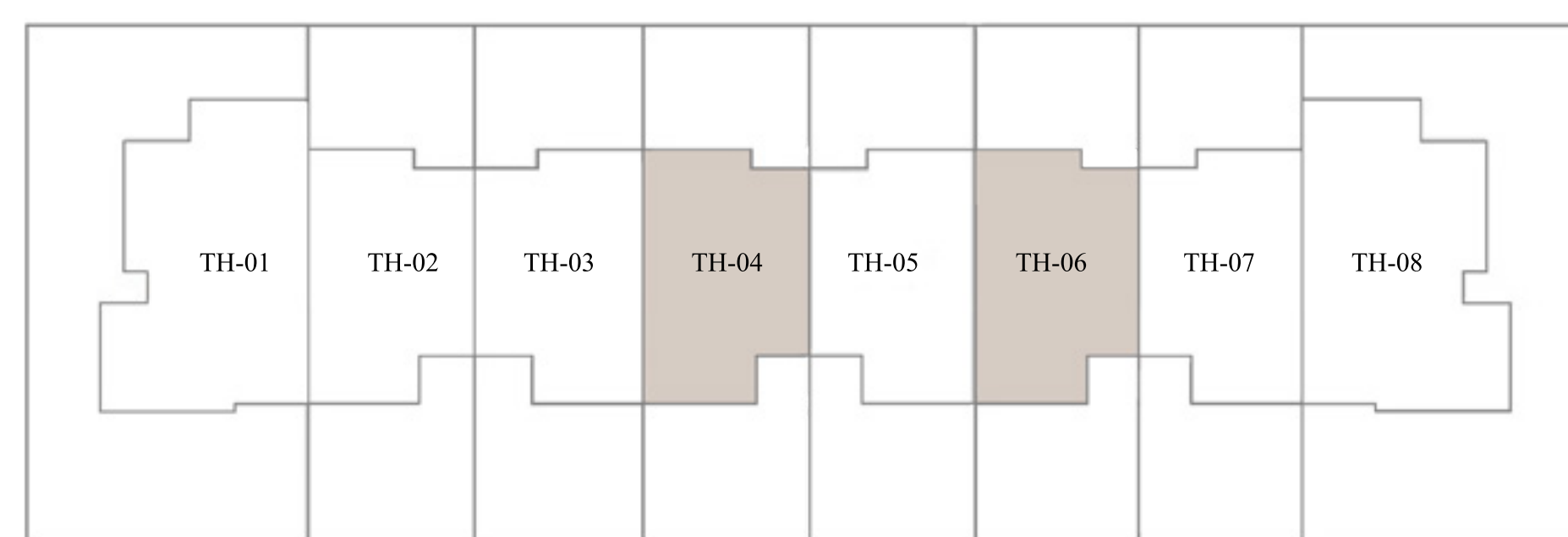

8 PLEX - TH04, TH06

DLG
DUBAI LUXURY GUY

@DUBAILUXURYGUY
 +97150 100 5593
 +97150 840 3520

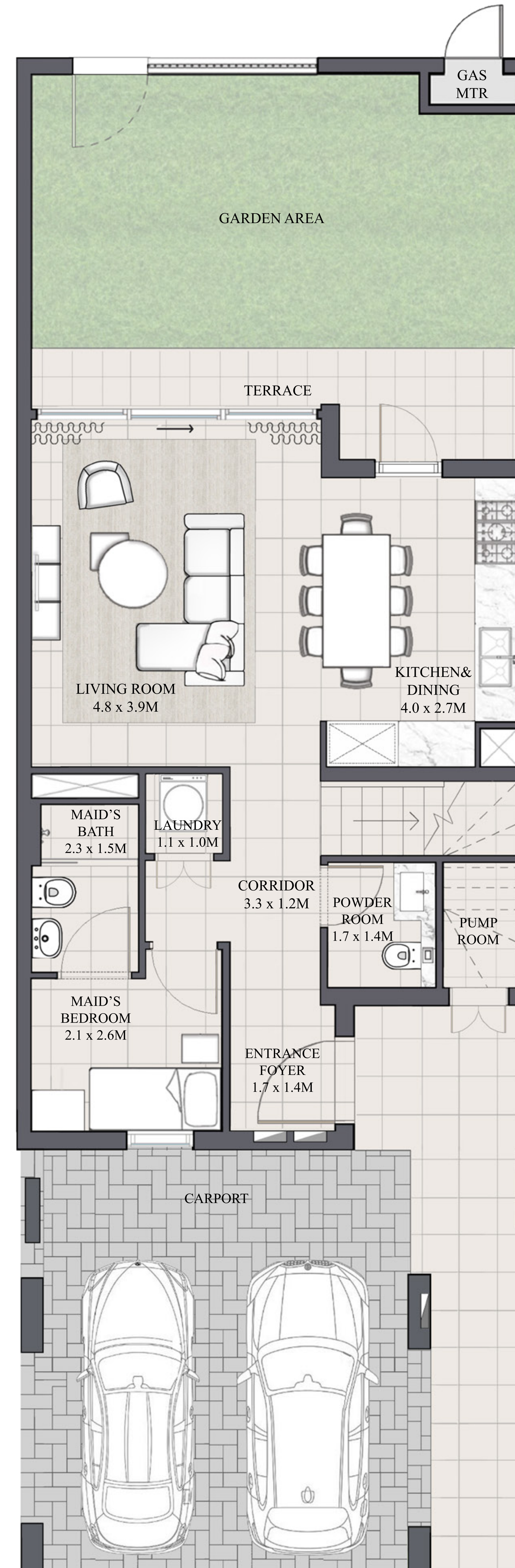

GROUND FLOOR

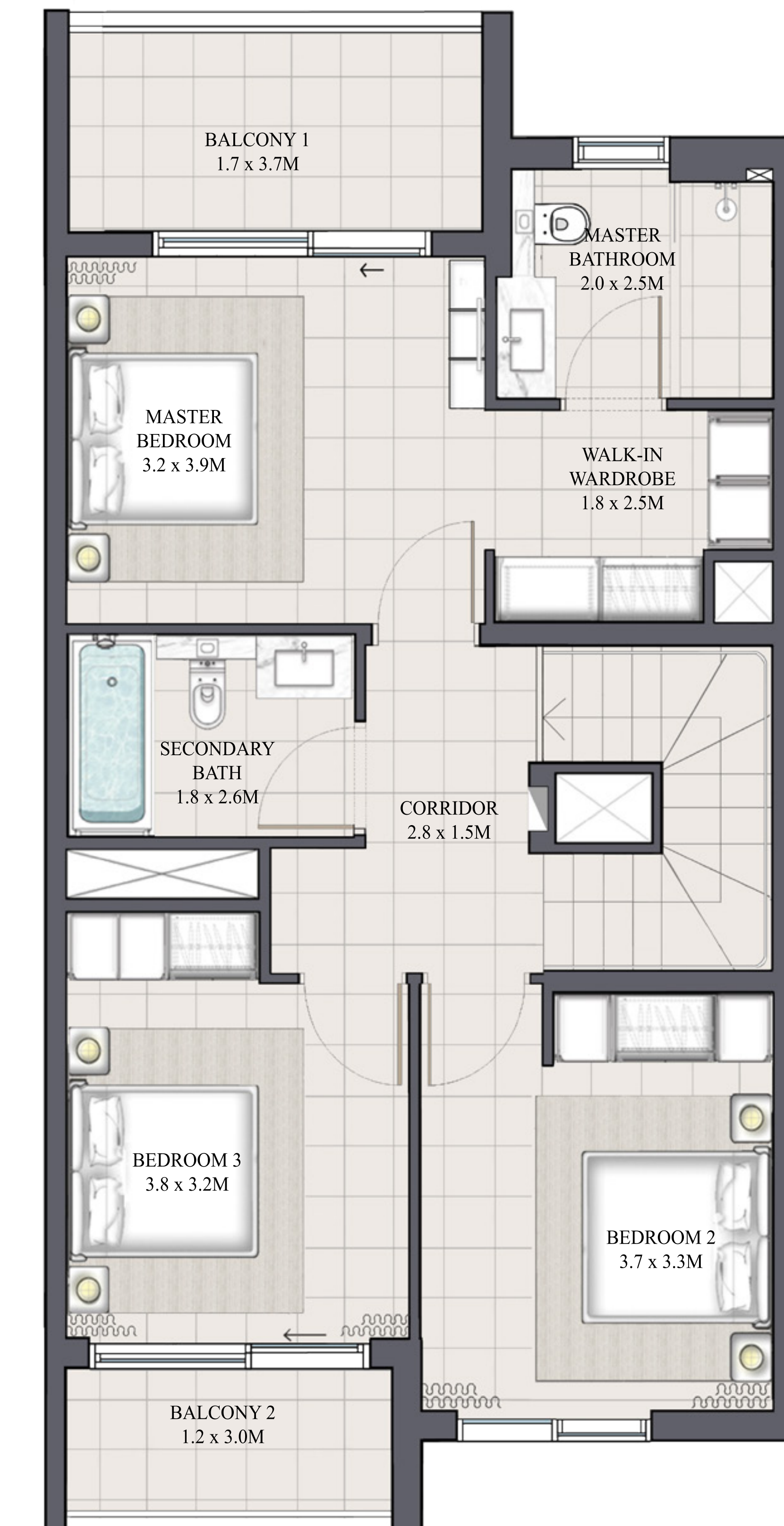

FIRST FLOOR

FLOOR PLAN 1. All dimensions are in imperial and metric, and measured from finish to finish excluding construction tolerances. 2. All materials, dimensions, and drawings are approximate only. 3. Information is subject to change without notice, at developer's absolute discretion. 4. Actual area may vary from the stated area. 5. Drawings not to scale. 6. All images used are for illustrative purposes only and do not represent the actual size, features, specifications, fittings, and furnishings. 7. The developer reserves the right to make revisions / alterations, at its absolute discretion, without any liability whatsoever.

EMAAR